

STORNOPHONE 9000
FIXED RADIO STATION
CQF9xxx
ALL FREQUENCY BANDS
BASIC RADIO MANUAL

Service Coordination.

Date: 09.87.

Edition: 11

Publication no: 8313.9900-10

CQF9000
BASE STATION

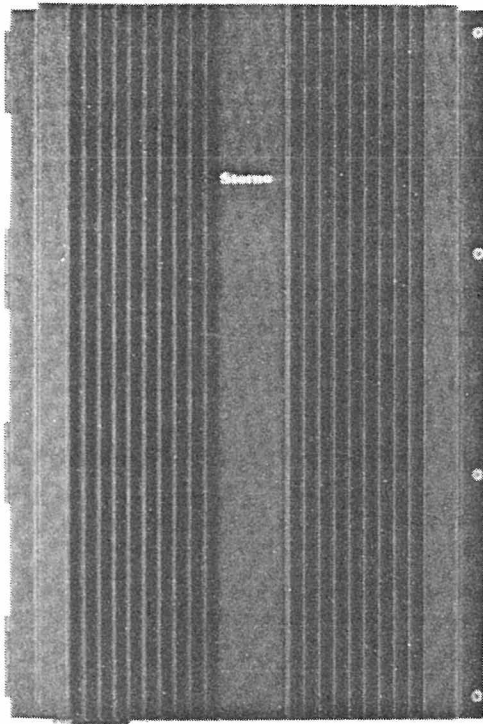

CLOSED RADIO CABINET

REAR OF THE CLOSED RADIO
CABINET WITH CONNECTORS

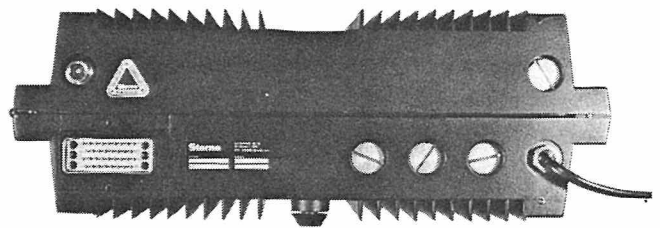

RADIO CABINET OPEN

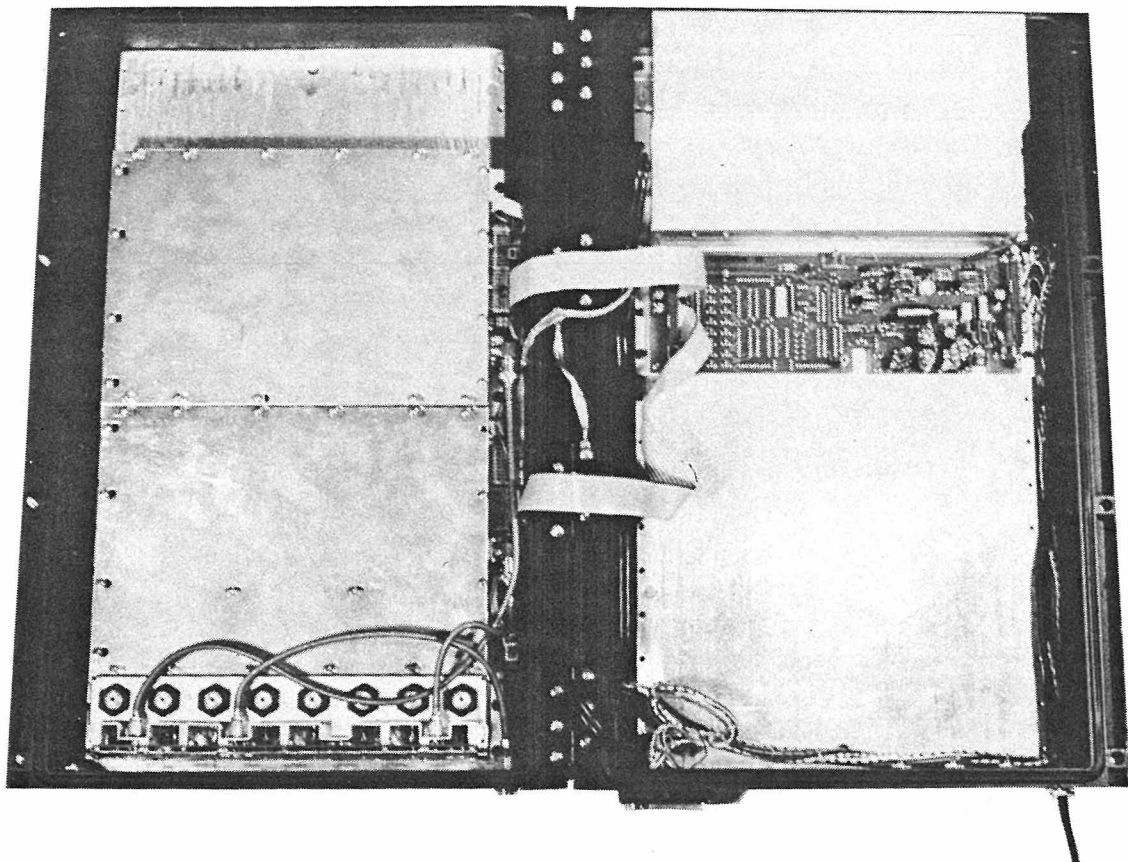

60.963-E4

VOLUME I
BASIC RADIO MANUAL
CQF9000

APPENDIX:
GRAPHICAL SYMBOLS
COLOUR CODE

ADDITIONAL MANUALS:
VOLUME II MODULE MANUAL

RADIO NOMENCLATURE
STRUCTURED OPTIONS
OSCILLATOR SURVEY

1

TECHNICAL SPECIFICATIONS

2

GENERAL DESCRIPTION
MODULE SURVEY
MECHANICAL DRAWING AND PARTS LISTS
INTERCONNECTION DIAGRAMS

3

INSTALLATION

4

INTERFACE TO CONTROL EQUIPMENT

5

FREQUENCY CALCULATION

6

ADJUSTMENT PROCEDURE

7

8

9

BLOCK DIAGRAMS
FUNCTIONAL DIAGRAMS

10

Storno

CQF9xxx

COMBINATION NUMBER RADIO EQUIPMENT

The following matrix describes the "combination number" specified by 17 digit figuring on the type plate at the rear of the radio cabinet. This matrix allow you to verify that the received radio equipment corresponds to the one you ordered.

The columns represents the variation in the basic parameters such as frequency band, channel spacing, transmitter power, channel capacity etc.

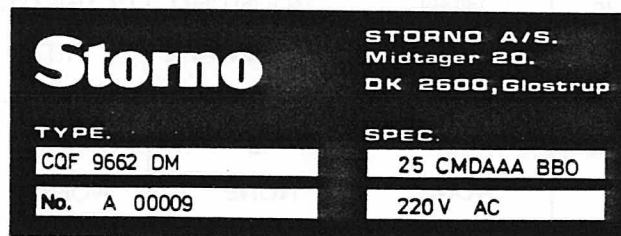

TYPE						SPECIFICATION						
DIGIT 01-04	DIGIT 05	DIGIT 06	DIGIT 07	DIGIT 08	DIGIT 09	DIGIT 10-11	DIGIT 12	DIGIT 13	DIGIT 14	DIGIT 15	DIGIT 16	DIGIT 17
PRODUCT CODE	TX FREQ. RANGE	RX FREQ. RANGE	CHANNEL SPACING	RADIO TYPE I	MULTIPL. / SYNTH. I	TX POWER OUTPUT	RADIO TYPE II	MULTIPL. / SYNTH. II	COUNTRY CODE	FREQ. STABILITY	POWER SUPPLY	CONTROL SYSTEM
CQF9 Fixed 9000	1 138-174 MHz	1 138-174 MHz	2 25 kHz	S Simplex	M Multiplier	0 0 0 W No Transmitter	A HI IM ⁺ Simplex w. AS	M Multiplier Multichannel (options)	A STAS EXPORT	A ±2 ppm -30/+60°C (UHF)	A 110/220 V AC, No limitation	A 600 stand. compati- bility
	3 66-88 MHz	3 66-88 MHz	3 20 kHz	D Duplex	Z Synthesizer	1 0 10 W	B HI SE ⁺ Simplex w. AS	N Multiplier 1 channel	D STAS DENMARK	B ±4 ppm -20/+55°C (VHF)	B +12 V DC No limitation	B CAF9000
	5 360-410 MHz	5 360-410 MHz	4 12.5 kHz			1 8 18 W	C HI IM ⁺ Duplex w. D. Filter	S Synthesizer Inter-leaved channels	E SLTD UK	C ±5.3 ppm -20/+55°C (VHF)	C +24 V DC Max 18W Dupl Max 25W Simp	
	6 403-470 MHz	6 403-470 MHz				2 5 25 W	D HI IM ⁺ Duplex w. 2 Ant.	Z Synthesizer Full channel	F STOF FRANCE		D 18- 36 V DC	
	N No transmitter	N No receiver				3 5 35 W (360- 410 MHz)	E HI IM ⁺ Simplex w. 2 Ant.		G STEL GERMANY		E 38- 72 V DC	
	M No transmitter (RX tray only)	M No receiver (TX tray only)				4 0 40 W	F HI SE ⁺ Simplex w. 2 Ant.					
							N No receiver					

⁺HI IM= High intermodulation attenuation
⁺HI SE= High sensitivity

The standard condition "0" of the columns 13, 14, 16 and 17 depends on how the previous columns are specified - e.g. the package size depends on radio type and transmitter power.

When specifying the standard condition, indicated by a zero, the correct oscillator, package size, receiver front end etc., will automatically be selected.

CQF9xxx

STRUCTURED OPTION

The last digits on the type plate specification indicates the structured options.

The matrix below explain the signification of the letters and ciphers which can be used.

SPECIFICATIONS					
A NO. OF TX FREQ.	B NO. OF RX FREQ.	P HIGH ISOLATION	R MOUNTING HARDWARE	K CONNECTOR KIT	F RSSI FEATURE
0 NONE	0 NONE	0 NONE	0 NONE	0 NONE	0 NONE
A 1	A 1	1 ISOLATOR	1 KIT WITHOUT SNAPLOCK	1 CONNECTOR KIT	A RSSI FEAT- TURE ADDED
B 2	B 2		2 KIT WITH SNAPLOCK		
C 3	C 3				
Z SYNTH.	D 4				
	E 5				
	Z SYNTH.				

ex.: The drawing of a type plate on the previous page shows as last digits:

B B 0

it means that this radio is able to use two TX frequencies, two RX frequencies and is not equipped with an isolator.

CQF9xxx

OVERTONE OSCILLATOR SURVEY

CQF9110

MULT. /SYNTH. Digit 13	STAB	X-TAL	TX SIDE			MODULES		RX SIDE		
			OSC. TYPE	OSCILLATOR PART No.	X-TAL FREQ. RANGE			X-TAL FREQ. RANGE	OSCILLATOR PART No.	OSC. TYPE
ZS Synthesizer	B ± 4 ppm	J707566P1	XO906	A701453G39	41.725-52.89	EX911	FG912	34.6-45.75	A701453G6	XO905
NM Multiplier			XO906	A701453C40	46.00-58.00	EX912	FG913	38.25-50.87	A701453G8	XO905

CQF9330

MULT. /SYNTH. Digit 13	STAB	X-TAL	TX SIDE			MODULES		RX SIDE		
			OSC. TYPE	OSCILLATOR PART No.	X-TAL FREQ. RANGE			X-TAL FREQ. RANGE	OSCILLATOR PART No.	OSC. TYPE
ZS Synthesizer	C ± 5.3 ppm	J707566P5	XO931	D900455G1	41.00-50.40	EX931	FG932	51.70-61.10	D900455G2	XO932
NM Multiplier		J707568P4	XO933	D900455G3	16.50-22.00	EX932	FG933	43.70-54.70	D900455G4	XO934

CQF9550

MULT. /SYNTH. Digit 13	STAB	X-TAL	TX SIDE			MODULES		RX SIDE		
			OSC. TYPE	OSCILLATOR PART No.	OSC. FREQ. RANGE			OSC. FREQ. RANGE	OSCILLATOR PART No.	OSC. TYPE
ZS Synthesizer	A ± 2 ppm	incl. in osc.	XO902	J707948G3	112.4-132.4	PL952	PL951	105.0-125.3	J707948G4	XO901

CQF9660

MULT. /SYNTH. Digit 13	STAB	X-TAL	TX SIDE			MODULES		RX SIDE		
			OSC. TYPE	OSCILLATOR PART No.	OSC. FREQ. RANGE			OSC. FREQ. RANGE	OSCILLATOR PART No.	OSC. TYPE
ZS Synthesizer NM Multiplier	A ± 2 ppm	incl. in osc.	XO902	J707948G1	129.0-157.0	PL961 EX961	PL962 FG961	122.0-150.00	J707948G2	XO901

TECHNICAL SPECIFICATIONS

CQF9110

(Simplex and duplex specifications are same unless otherwise noted)

FREQUENCY RANGE

138 - 174 MHz

CHANNEL SPACING

CQF9112: 25 kHz
CQF9113: 20 kHz
CQF9114: 12.5 kHz

FREQUENCY STABILITY

± 4 ppm

RECEIVER

SINAD SENSITIVITY

EIA: 12 dB ($\frac{1}{2}$ emf)
CEPT: 20 dB psophometric

High intermodulation attenuation (RC911)

Simplex: 0.35 μ V (EIA), 0.75 μ V (CEPT)
Duplex: 0.45 μ V (EIA), 0.95 μ V (CEPT)

High Sensitivity (RC912)

EIA: 0.20 μ V
CEPT: 0.45 μ V

(only simplex)

20 dB QUIETING SENSITIVITY

High intermodulation attenuation (RC911) EIA

Simplex: 0.50 μ V
Duplex: 0.63 μ V

High Sensitivity (RC912) EIA

0.30 μ V (simplex only)

NOMINAL INPUT IMPEDANCE

50 ohm

MODULATION ACCEPTANCE BANDWIDTH

CQF9112: ± 7.0 kHz (EIA, CEPT)
CQF9113: ± 6.0 kHz (FTZ)
CQF9114: ± 3.0 kHz (EIA, CEPT)

ADJACENT CHANNEL SELECTIVITY

CQF9112: 90 dB (EIA, CEPT)⁺
CQF9113: 90 dB (EIA, FTZ)⁺
CQF9114: 70 dB (EIA, CEPT)

⁺Degraded by 5 dB when a channel synthesizer is used in the system except for CQF9114.

INTERMODULATION ATTENUATION

TYPE	CHANNEL SPACING	RECEIVER FRONT-END	
		RC911	RC912
CQF9112	25 kHz	80 dB	75 dB
CQF9113	20 kHz	70 dB	70 dB
CQF9114	12.5 kHz	70 dB	70 dB

CQF9112/9114: EIA and CEPT

CQF9113: EIA and FTZ

DESENTIZATION

90 dB CEPT

CO-CHANNEL REJECTION

less than 8 dB CEPT

CONDUCTED SPURIOUS

2 nW (-57 dBm) CEPT

SPURIOUS REJECTION CEPT

Simplex: 90 dB

Duplex TX keyed: 75 dB

Duplex TX unkeyed: 90 dB

RADIATED SPURIOUS

2 nW (-57 dBm) CEPT

DUPLEX SPACING

4.5 MHz to 12 MHz

MAX. RECEIVER CHANNEL BANDWIDTH

MODE	RECEIVER FRONT - END FULL SPECIFICATION		RECEIVER FRONT - END 3 dB DEGRADATION ⁺	
	RC911	RC912	RC911	RC912
	HIGH INTER-MOD. ATT.	HIGH SENSITIVITY	HIGH INTER-MOD. ATT.	HIGH SENSITIVITY
SIMPLEX	1.0 MHz	2.0 MHz	1.4 MHz	3.0 MHz
DUPLEX 4.5 MHz	0.7 MHz		1.0 MHz	
DUPLEX 6 MHz	0.9 MHz		1.2 MHz	
DUPLEX 8 MHz	1.0 MHz		1.3 MHz	
DUPLEX 10-12 MHz	1.0 MHz		1.3 MHz	

⁺Degradation with respect to sensitivity

AUDIO OUTPUT LEVELS

Deemphasised line output

600 ohm ±20% - transformer coupled - floating - gated.

2 mW ±0.5 dB (fm= 1000 Hz, Δf= 0.7 Δf max.)

Non-deemphasised - gated

- Source impedance assymetrical.

- Min. load impedance 2 Kohm.

- Level 300 mW ±0.5 dB with fm= 1000 Hz and Δf= 0.7 Δf max.

- AC coupled.

Non-deemphasised - non-gated

- Source impedance asymmetrical.
- Min. load impedance 2 Kohm.
- Level 300 mW \pm 0.5 dB with fm= 1000 Hz and $\Delta f = 0.7 \Delta f$ max.
- DC= approx. 4.5 V.

AUDIO DISTORTION

Less than 10% CEPT, extreme conditions
Less than 5% typical

AUDIO FREQUENCY RESPONSE

Deemphasised line output

20/25 kHz channel spacing:

- 6 dB/octave +1/-3 dB, 300-3000 Hz
- 6 dB/octave +1/-1.5 dB, 400-2700 Hz

12.5 kHz channel spacing:

- 6 dB/octave +1/-3 dB, 300-2500 Hz

Above 3000 Hz - 3-pole butterworth response -
fc= 3500 Hz

Non-deemphasised - gated

Flat +1/-3 dB, 50-3000 Hz

Above 3000 Hz - 3-pole butterworth response -
fc= 3500 Hz

Non-deemphasised - non-gated

Flat +1/-3 dB, 50-150 kHz

This output provides out-of-band noise signal
for diversity applications.

AUDIO NOISE LEVEL

Unsquelled

CQF9112: 50 dB
CQF9113: 50 dB
CQF9114: 44 dB

Squelled

CQF9112: 70 dB
CQF9113: 70 dB
CQF9114: 60 dB

SQUELCH ATTACK TIME

Slow squelch (audio path)

Threshold (critical setting) <200 ms
25 dB SINAD (fully tightened) <40 ms

Fast squelch (scanning applications)

Threshold +6 dB RF <5 ms
25 dB SINAD (fully tightened) <5 ms

SQUELCH RELEASE TIME

Slow squelch (audio path)

Threshold (critical setting) <300 ms
25 dB SINAD (fully tightened) <10 ms

Fast squelch (scanning applications)

Threshold +6 dB <5 ms
25 dB SINAD (fully tightened) <5 ms

CRITICAL SQUELCH SENSITIVITY

4.0 dB SINAD

MAXIMUM SQUELCH SENSITIVITY

Greater than or equal to 20 dB quieting
 Less than or equal to 1.5 uV RF input

SQUELCH BLOCKING

CQF9112: Greater than ±5.0 kHz
 CQF9114: Greater than ±2.5 kHz

DUTY CYCLE

Continuous

TRANSMITTER

FREQUENCY RANGE

138 - 174 MHz

AM HUM AND NOISE (EIA)

-50 dB

CHANNEL SPACING

CQF9112: 25 kHz
 CQF9113: 20 kHz
 CQF9114: 12.5 kHz

POWER OUTPUT

Simplex, intermittent duty: 40/25/10 W
 Duplex, continuous duty: 25/18/6 W

FREQUENCY STABILITY

±4 ppm

LOAD IMPEDANCE

50 ohm

FM HUM AND NOISE (EIA/CEPT)

	Multiplier	Synthesizer
25 kHz channel spacing:	-60 dB	-50 dB
20 kHz channel spacing:	-60 dB	-50 dB
12.5 kHz channel spacing:	-50 dB	-45 dB

POWER ADJUSTMENT RANGE

Adjustable 3:1

MAX. TRANSMITTER CHANNEL BANDWIDTH

OPERATING MODE	FULL SPECIFICATIONS		3 dB DEGRADATION [†]	
	SYNTHESIZER	MULTIPLIER	SYNTHESIZER	MULTIPLIER
SIMPLEX	3.5 MHz	6.0 MHz	3.5 MHz	6.0 MHz
DUPLEX 4.5 MHz	0.7 MHz	0.7 MHz	1.0 MHz	1.0 MHz
DUPLEX 6 MHz	0.9 MHz	0.9 MHz	1.2 MHz	1.2 MHz
DUPLEX 8 MHz	1.1 MHz	1.1 MHz	1.3 MHz	1.3 MHz
DUPLEX 12 MHz	1.5 MHz	1.5 MHz	1.8 MHz	1.8 MHz

[†]Degradation with respect to output power

DUPLEX SPACING

4.5 MHz to 12 MHz

PA PROTECTION TO LOAD VARIATION

No damage for 0 to ∞ impedance loads and all phase angles.

ADJACENT CHANNEL POWER

EIA/CEPT/SWEDEN

20 - 25 kHz: -70 dB

12.5 kHz: -60 dB

MAXIMUM FREQUENCY DEVIATION

25 kHz Channel spacing:

EIA/CEPT max. ± 5 kHzFTZ max. ± 4 kHz

20 kHz Channel spacing:

EIA max. ± 4 kHz

12.5 kHz Channel spacing:

CEPT max. ± 2.5 kHz

AUDIO SENSITIVITY FOR RATED DEVIATION (1000 Hz)

100 mV ± 3 dB (EIA/CEPT)

CHANNEL GUARD INPUT

300 mV ± 3 dB at 100 Hz, 10% Δf max.

CONDUCTED SPURIOUS (EIA/CEPT)

Harmonics: 0.25 μ WOther: 0.20 μ W

RADIATED SPURIOUS EIA/CEPT

0.20 μ W

AUDIO FREQUENCY CHARACTERISTICS

Speech processed input

- Impedance 600 ohm $\pm 20\%$ - transformer coupled - floating.
- Response 6 dB/octave +1/-3 dB - 300 to 3000 Hz
- Response 6 dB/octave +1/-1.5 dB - 400 to 2700 Hz
The above applies in 20 and 25 kHz channel spacing systems.
- Response 6 dB/octave +0.5/-3 dB - 300 to 2500 Hz
The above applies in 12.5 kHz channel spacing systems.

Channel Guard input

- Impedance adjustment dependent > 5.6 Kohm.
- DC level approx. 4.5 V.
- Response flat ± 1 dB from 50 to 250 Hz.

AUDIO DISTORTION

Less than 5% (1000 Hz, 60% modulation)

TRANSMIT ATTACK TIME

5 ms

TRANSMIT DECAY TIME

5 ms

TECHNICAL SPECIFICATIONS

CQF9330

(Simplex and duplex specifications are same unless otherwise noted)

FREQUENCY RANGE

68 - 88 MHz

CHANNEL SPACING

CQF9332: 25 kHz
 CQF9333: 20 kHz
 CQF9334: 12.5 kHz

FREQUENCY STABILITY

± 4 ppm

RECEIVER

SINAD SENSITIVITY

EIA: 12 dB (½ emf)
 CEPT: 20 dB psophometric

High intermodulation attenuation

Simplex: 0.35 uV (EIA), 0.75 uV (CEPT)
 Duplex: 0.45 uV (EIA), 0.95 uV (CEPT)

20 dB QUIETING SENSITIVITY

High intermodulation attenuation (RC931) EIA

Simplex: 0.50 uV
 Duplex: 0.63 uV

NOMINAL INPUT IMPEDANCE

50 ohm

MODULATION ACCEPTANCE BANDWIDTH

CQF9332: ±7.0 kHz (EIA, CEPT)
 CQF9333: ±6.0 kHz (FTZ)
 CQF9334: ±3.0 kHz (EIA, CEPT)

ADJACENT CHANNEL SELECTIVITY

CQF9332: 90 dB (EIA, CEPT)⁺
 CQF9333: 90 dB (EIA, FTZ)⁺
 CQF9334: 70 dB (EIA, CEPT)

⁺Degraded by 5 dB when a channel synthesizer is used in the system except for CQF9334.

INTERMODULATION ATTENUATION

TYPE	CHANNEL SPACING	RECEIVER FRONT-END RC931
CQF9332	25 kHz	80 dB
CQF9333	20 kHz	70 dB
CQF9334	12.5 kHz	75 dB

CQF9332/9334: EIA and CEPT
 CQF9333: EIA and FTZ

SPURIOUS REJECTION CEPT

Simplex: 90 dB
 Duplex TX keyed: 75 dB
 Duplex TX unkeyed: 90 dB

CONDUCTED SPURIOUS

2 nW (-57 dBm) CEPT

RADIATED SPURIOUS

DESENSITIZATION

90 dB CEPT

2 nW (-57 dBm) CEPT

DUPLEX SPACING

CO-CHANNEL REJECTION

less than 8 dB CEPT

4.5 MHz to 12 MHz

MAX. RECEIVER CHANNEL BANDWIDTH

MODE	RECEIVER FRONT - END FULL SPECIFICATION	RECEIVER FRONT - END 3 dB DEGRADATION ⁺
	RC931	RC931
	HIGH INTER-MOD. ATT.	HIGH INTER-MOD. ATT.
SIMPLEX	1.0 MHz	1.4 MHz
DUPLEX 4.5 MHz	0.7 MHz	1.0 MHz
DUPLEX 6 MHz	0.9 MHz	1.2 MHz
DUPLEX 7-10 MHz	1.0 MHz	1.3 MHz

⁺Degradation with respect to output power

AUDIO OUTPUT LEVELS

Deemphasised line output

600 ohm ±20% - transformer coupled - floating - gated.
 2 mW ±0.5 dB (fm= 1000 Hz, Δf= 0.7 Δf max.)

Non-deemphasised - gated

- Source impedance assymetrical.
- Min. load impedance 2 Kohm.
- Level 300 mW ±0.5 dB with fm= 1000 Hz and Δf= 0.7 Δf max.
- AC coupled.

Non-deemphasised - non-gated

- Source impedance assymetrical.
- Min. load impedance 2 Kohm.
- Level 300 mW ±0.5 dB with fm= 1000 Hz and Δf= 0.7 Δf max.
- DC= approx. 4.5 V.

AUDIO DISTORTION

Less than 10% CEPT, extreme conditions
 Less than 5% typical

AUDIO FREQUENCY RESPONSE

Deemphasised line output

20/25 kHz channel spacing:

-6 dB/octave +1/-3 dB, 300-3000 Hz

-6 dB/octave +1/-1.5 dB, 400-2700 Hz

12.5 kHz channel spacing:

-6 dB/octave +1/-3 dB, 300-2500 Hz

Above 3000 Hz - 3-pole butterworth response -
fc= 3500 HzNon-deemphasised - gated

Flat +1/-3 dB, 50-3000 Hz

Above 3000 Hz - 3-pole butterworth response -
fc= 3500 HzNon-deemphasised - non-gated

Flat +1/-3 dB, 50-150 kHz

This output provides out-of-band noise signal
for diversity applications.

AUDIO NOISE LEVEL

Unsquelled

CQF9332: 50 dB

CQF9333: 50 dB

CQF9334: 44 dB

Squelled

CQF9332: 70 dB

CQF9333: 70 dB

CQF9334: 60 dB

SQUELCH ATTACK TIME

Slow squelch (audio path)

Threshold (critical setting) <200 ms

25 dB SINAD (fully tightened) <40 ms

Fast squelch (scanning applications)

Threshold +6 dB RF <5 ms

25 dB SINAD (fully tightened) <5 ms

SQUELCH RELEASE TIME

Slow squelch (audio path)

Threshold (critical setting) <300 ms

25 dB SINAD (fully tightened) <10 ms

Fast squelch (scanning applications)

Threshold +6 dB <5 ms

25 dB SINAD (fully tightened) <5 ms

CRITICAL SQUELCH SENSITIVITY

4.0 dB SINAD

MAXIMUM SQUELCH SENSITIVITY

Greater than or equal to 20 dB quieting

Less than or equal to 1.5 uV RF input

SQUELCH BLOCKING

CQF9332: Greater than ± 5.0 kHzCQF9334: Greater than ± 2.5 kHz

DUTY CYCLE

Continuous

TRANSMITTER

FREQUENCY RANGE

68 - 88 MHz

POWER OUTPUT

Simplex, intermittent duty: 40/25/10 W
 Duplex, continuous duty: 25/18/6 W

CHANNEL SPACING

CQF9332: 25 kHz
 CQF9333: 20 kHz
 CQF9334: 12.5 kHz

LOAD IMPEDANCE

50 ohm

FREQUENCY STABILITY

± 4 ppm

POWER ADJUSTMENT RANGE

Adjustable 3:1

MAX. TRANSMITTER CHANNEL BANDWIDTH

OPERATING MODE	FULL SPECIFICATIONS		3 dB DEGRADATION [†]	
	SYNTHESIZER	MULTIPLIER	SYNTHESIZER	MULTIPLIER
SIMPLEX	3.2 MHz	2.0 MHz	3.2 MHz	2.0 MHz
DUPLEX 4.5 MHz	0.7 MHz	0.7 MHz	1.0 MHz	1.0 MHz
DUPLEX 6 MHz	0.9 MHz	0.9 MHz	1.2 MHz	1.2 MHz
DUPLEX 7-10 MHz	1.1 MHz	1.1 MHz	1.3 MHz	1.3 MHz

[†]Degradation with respect to output power

DUPLEX SPACING

4.5 MHz to 12 MHz

MAXIMUM FREQUENCY DEVIATION

25 kHz Channel spacing:
 EIA/CEPT max. ±5 kHz
 FTZ max. ±4 kHz

PA PROTECTION TO LOAD VARIATION

No damage for 0 to ∞ impedance loads and all phase angles.

20 kHz Channel spacing:
 EIA max. ±4 kHz

ADJACENT CHANNEL POWER

EIA/CEPT/SWEDEN
 20 - 25 kHz: -70 dB
 12.5 kHz: -60 dB

12.5 kHz Channel spacing:
 CEPT max. ±2.5 kHz

AUDIO SENSITIVITY FOR RATED DEVIATION (1000 Hz)

100 mV ±3 dB (EIA/CEPT)

CHANNEL GUARD INPUT

300 mV ±3 dB at 100 Hz, 10% Δf max.

CONDUCTED SPURIOUS (EIA/CEPT)

Harmonics: 0.25 μW

Other: 0.20 μW

RADIATED SPURIOUS EIA/CEPT

0.20 μW

FM HUM AND NOISE (EIA/CEPT)

	Multiplier	Synthesizer
25 kHz channel spacing:	-60 dB	-50 dB
20 kHz channel spacing:	-60 dB	-50 dB
12.5 kHz channel spacing:	-50 dB	-45 dB

AM HUM AND NOISE (EIA)

-50 dB

AUDIO FREQUENCY CHARACTERISTICS

Speech processed input

- Impedance 600 ohm ±20% - transformer coupled - floating.
- Response 6 dB/octave +1/-3 dB - 300 to 3000 Hz
- Response 6 dB/octave +1/-1.5 dB - 400 to 2700 Hz
The above applies in 20 and 25 kHz channel spacing systems.
- Response 6 dB/octave +0.5/-3 dB - 300 to 2500 Hz
The above applies in 12.5 kHz channel spacing systems.

Channel Guard input

- Impedance adjustment dependent >5.6 Kohm.
- DC level approx. 4.5 V.
- Response flat ±1 dB from 50 to 250 Hz.

AUDIO DISTORTION

Less than 5% (1000 Hz, 60% modulation)

TRANSMIT ATTACK TIME

5 ms

TRANSMIT DECAY TIME

5 ms

TECHNICAL SPECIFICATIONS

CQF9550

(Simplex and duplex specifications are same unless otherwise noted)

FREQUENCY RANGE

360 - 410 MHz

CHANNEL SPACING

CQF9552: 25 kHz

CQF9554: 12.5 kHz

FREQUENCY STABILITY

±2 ppm

RECEIVER

SINAD SENSITIVITY

EIA: 12 dB ($\frac{1}{2}$ emf)

CEPT: 20 dB psophometric

High intermodulation attenuation (RC953)

Simplex: 0.35 μ V (EIA), 0.75 μ V (CEPT)

Duplex: 0.45 μ V (EIA), 1.00 μ V (CEPT)

20 dB QUIETING SENSITIVITY

High intermodulation attenuation (RC953) EIA

Simplex: 0.50 μ V

Duplex: 0.63 μ V

NOMINAL INPUT IMPEDANCE

50 ohm

MODULATION ACCEPTANCE BANDWIDTH

CQF9552: ±7.0 kHz (EIA, CEPT)

CQF9553: ±6.0 kHz (FTZ)

CQF9554: ±3.0 kHz (EIA, CEPT)

ADJACENT CHANNEL SELECTIVITY

CQF9552: 80 dB (EIA, CEPT)⁺

CQF9553: 80 dB (EIA, FTZ)⁺

CQF9554: 65 dB (EIA, CEPT)

INTERMODULATION ATTENUATION

TYPE	CHANNEL SPACING	RECEIVER FRONT-END RC953
CQF9552	25 kHz	80 dB
CQF9554	12.5 kHz	70 dB

CQF9552/9554: EIA and CEPT

SPURIOUS REJECTION CEPT

Simplex: 90 dB
 Duplex TX keyed: 75 dB
 Duplex TX unkeyed: 90 dB

DESENSITIZATION

90 dB CEPT

CO-CHANNEL REJECTION

less than 8 dB CEPT

CONDUCTED SPURIOUS

2 nW (-57 dBm) CEPT

RADIATED SPURIOUS

2 nW (-57 dBm) CEPT

DUPLEX SPACING

4.5 MHz to 12 MHz

MAX. RECEIVER CHANNEL BANDWIDTH

MODE	RECEIVER FRONT - END FULL SPECIFICATION	RECEIVER FRONT - END 3 dB DEGRADATION [†]
	RC953	RC953
	HIGH INTER-MOD. ATT.	HIGH INTER-MOD. ATT.
SIMPLEX	3.0 MHz	4.0 MHz
DUPLEX 4.5 MHz	0.8 MHz	1.2 MHz
DUPLEX 6 MHz	1.3 MHz	1.8 MHz
DUPLEX 8 MHz	1.8 MHz	2.5 MHz
DUPLEX 10-12 MHz	2.0 MHz	2.5 MHz

[†]Degradation with respect to sensitivity

AUDIO OUTPUT LEVELS

Deemphasised line output

600 ohm ±20% - transformer coupled - floating - gated.
 2 mW ±0.5 dB (fm= 1000 Hz, Δf= 0.7 Δf max.)

Non-deemphasised - gated

- Source impedance assymetrical.
- Min. load impedance 2 Kohm.
- Level 300 mW ±0.5 dB with fm= 1000 Hz and Δf= 0.7 Δf max.
- AC coupled.

Non-deemphasised - non-gated

- Source impedance assymetrical.
- Min. load impedance 2 Kohm.
- Level 300 mW ± 0.5 dB with fm= 1000 Hz and $\Delta f = 0.7 \Delta f$ max.
- DC= approx. 4.5 V.

AUDIO DISTORTION

Less than 10% CEPT, extreme conditions
Less than 5% typical

AUDIO FREQUENCY RESPONSE

Deemphasised line output

25 kHz channel spacing:

- 6 dB/octave +1/-3 dB, 300-3000 Hz
- 6 dB/octave +1/-1.5 dB, 400-2700 Hz

12.5 kHz channel spacing:

- 6 dB/octave +1/-3 dB, 300-2500 Hz

Above 3000 Hz - 3-pole butterworth response -
fc= 3500 Hz

Non-deemphasised - gated

Flat +1/-3 dB, 50-3000 Hz

Above 3000 Hz - 3-pole butterworth response -
fc= 3500 Hz

Non-deemphasised - non-gated

Flat +1/-3 dB, 50-150 kHz

This output provides out-of-band noise signal
for diversity applications.

AUDIO NOISE LEVEL

Unsquelled

CQF9552: 50 dB
CQF9554: 44 dB

Squelched

CQF9552: 70 dB
CQF9554: 60 dB

SQUELCH ATTACK TIME

Slow squelch (audio path)

Threshold (critical setting) <200 ms
25 dB SINAD (fully tightened) <40 ms

Fast squelch (scanning applications)

Threshold +6 dB RF <5 ms
25 dB SINAD (fully tightened) <5 ms

SQUELCH RELEASE TIME

Slow squelch (audio path)

Threshold (critical setting) <300 ms
25 dB SINAD (fully tightened) <10 ms

Fast squelch (scanning applications)

Threshold +6 dB <5 ms
25 dB SINAD (fully tightened) <5 ms

CRITICAL SQUELCH SENSITIVITY

4.0 dB SINAD (25°C)

MAXIMUM SQUELCH SENSITIVITY

Greater than or equal to 20 dB quieting
Less than or equal to 1.5 μ V RF input

SQUELCH BLOCKING

CQF9552: Greater than ± 5.0 kHz
CQF9554: Greater than ± 2.5 kHz

DUTY CYCLE

Continuous

TRANSMITTER

FREQUENCY RANGE

360 - 410 MHz

POWER OUTPUT

Simplex, intermittent duty: 30 W
 Duplex, continuous duty: 20 W

CHANNEL SPACING

CQF9552: 25 kHz
 CQF9554: 12.5 kHz

LOAD IMPEDANCE

50 ohm

FREQUENCY STABILITY

±2 ppm

POWER ADJUSTMENT RANGE

Adjustable 3:1

MAX. TRANSMITTER CHANNEL BANDWIDTH

OPERATING MODE	FULL SPECIFICATIONS	3 dB DEGRADATION ⁺
	SYNTHESIZER	SYNTHESIZER
SIMPLEX	3.6 MHz	
DUPLEX 4.5 MHz	0.8 MHz	1.2 MHz
DUPLEX 6 MHz	1.3 MHz	1.8 MHz
DUPLEX 8 MHz	2.0 MHz	2.0 MHz
DUPLEX 10-15 MHz	2.5 MHz	3.5 MHz

⁺Degradation with respect to output power

DUPLEX SPACING

4.5 MHz to 12 MHz

ADJACENT CHANNEL POWER

EIA/CEPT/SWEDEN
 25 kHz: -70 dB
 12.5 kHz: -60 dB

PA PROTECTION TO LOAD VARIATION

No damage for 0 to ∞ impedance loads and all phase angles.

MAXIMUM FREQUENCY DEVIATION

25 kHz Channel spacing:
 EIA/CEPT max. ±5 kHz
 FTZ max. ±4 kHz

12.5 kHz Channel spacing:
 CEPT max. ±2.5 kHz

AUDIO SENSITIVITY FOR RATED DEVIATION (1000 Hz)

100 mV ±3 dB (EIA/CEPT)

CHANNEL GUARD INPUT

300 mV ±3 dB at 100 Hz, 10% Δf max.

CONDUCTED SPURIOUS (EIA/CEPT)

Harmonics: 0.25 uW
 Other: 0.20 uW

RADIATED SPURIOUS EIA/CEPT

0.20 uW

FM HUM AND NOISE (EIA/CEPT)

	Multiplier	Synthesizer
25 kHz channel spacing:	-60 dB	-50 dB
20 kHz channel spacing:	-60 dB	-50 dB
12.5 kHz channel spacing:	-50 dB	-45 dB

AM HUM AND NOISE (EIA)

-50 dB

AUDIO FREQUENCY CHARACTERISTICS

Speech processed input

- Impedance 600 ohm ±20% - transformer coupled - floating.
 - Response 6 dB/octave +1/-3 dB - 300 to 3000 Hz
 - Response 6 dB/octave +1/-1.5 dB - 400 to 2700 Hz
- The above applies in 20 and 25 kHz channel spacing systems.

- Response 6 dB/octave +0.5/-3 dB - 300 to 2500 Hz
- The above applies in 12.5 kHz channel spacing systems.

Channel Guard input

- Impedance adjustment dependent >5.6 Kohm.
- DC level approx. 4.5 V.
- Response flat ±1 dB from 50 to 250 Hz.

AUDIO DISTORTION

Less than 5% (1000 Hz, 60% modulation)

TRANSMIT ATTACK TIME

5 ms

TRANSMIT DECAY TIME

5 ms

TECHNICAL SPECIFICATIONS

CQF9660

(Simplex and duplex specifications are same unless otherwise noted)

FREQUENCY RANGE

403 - 470 MHz

CHANNEL SPACING

CQF9662: 25 kHz
CQF9663: 20 kHz
CQF9664: 12.5 kHz

FREQUENCY STABILITY

±2 ppm

RECEIVER

SINAD SENSITIVITY

EIA: 12 dB ($\frac{1}{2}$ emf)
CEPT: 20 dB psophometric

High intermodulation attenuation (RC969)

Simplex: 0.35 μ V (EIA), 0.75 μ V (CEPT)
Duplex: 0.45 μ V (EIA), 1.00 μ V (CEPT)

High Sensitivity (RC962)

EIA: 0.20 μ V
CEPT: 0.45 μ V
(only simplex)

20 dB QUIETING SENSITIVITY

High intermodulation attenuation (RC969) EIA

Simplex: 0.50 μ V
Duplex: 0.63 μ V

High Sensitivity (RC962) EIA

0.30 μ V (simplex only)

NOMINAL INPUT IMPEDANCE

50 ohm

MODULATION ACCEPTANCE BANDWIDTH

CQF9662: ±7.0 kHz (EIA, CEPT)
CQF9663: ±6.0 kHz (FTZ)
CQF9664: ±3.0 kHz (EIA, CEPT)

ADJACENT CHANNEL SELECTIVITY

CQF9662: 85 dB (EIA, CEPT)⁺
CQF9663: 85 dB (EIA, FTZ)⁺
CQF9664: 70 dB (EIA, CEPT)

⁺Degraded by 5 dB when a channel synthesizer is used in the system except for CQF9664.

TECHNICAL SPECIFICATION, CQF9660

INTERMODULATION ATTENUATION

TYPE	CHANNEL SPACING	RECEIVER FRONT-END	
		RC969	RC962
CQF9662	25 kHz	80 dB	80 dB
CQF9663	20 kHz	70 dB	70 dB
CQF9664	12.5 kHz	70 dB	70 dB

DESENSITIZATION

90 dB CEPT

CO-CHANNEL REJECTION

less than 8 dB CEPT

CQF9662/9664: EIA and CEPT

CQF9663: EIA and FTZ

CONDUCTED SPURIOUS

2 nW (-57 dBm) CEPT

SPURIOUS REJECTION CEPT

Simplex: 90 dB

Duplex TX keyed: 75 dB

Duplex TX unkeyed: 90 dB

RADIATED SPURIOUS

2 nW (-57 dBm) CEPT

DUPLEX SPACING

4.5 MHz to 12 MHz

MAX. RECEIVER CHANNEL BANDWIDTH

MODE	RECEIVER FRONT - END FULL SPECIFICATION		RECEIVER FRONT - END 3 dB DEGRADATION ⁺	
	RC969	RC962	RC969	RC962
	HIGH INTER-MOD. ATT.	HIGH SENSITIVITY	HIGH INTER-MOD. ATT.	HIGH SENSITIVITY
SIMPLEX	1.8 MHz	2.5 MHz	2.5 MHz	3.5 MHz
DUPLEX 4.5 MHz	1.0 MHz		1.2 MHz	
DUPLEX 6 MHz	1.1 MHz		1.5 MHz	
DUPLEX 8 MHz	1.3 MHz		1.6 MHz	
DUPLEX 10-12 MHz	1.3 MHz		1.6 MHz	

⁺Degradation with respect to sensitivity

AUDIO OUTPUT LEVELS

Deemphasised line output

600 ohm ± 20% - transformer coupled - floating - gated.
2 mW ± 0.5 dB (fm= 1000 Hz, Δf= 0.7 Δf max.)

Non-deemphasised - gated

- Source impedance assymetrical.
- Min. load impedance 2 Kohm.
- Level 300 mW ± 0.5 dB with fm= 1000 Hz and Δf= 0.7 Δf max.
- AC coupled.

Non-deemphasised - non-gated

- Source impedance assymetrical.
- Min. load impedance 2 Kohm.
- Level 300 mW ± 0.5 dB with fm= 1000 Hz and $\Delta f = 0.7 \Delta f$ max.
- DC= approx. 4.5 V.

AUDIO DISTORTION

Less than 10% CEPT, extreme conditions
Less than 5% typical

AUDIO FREQUENCY RESPONSE

Deemphasised line output

20/25 kHz channel spacing:

- 6 dB/octave +1/-3 dB, 300-3000 Hz
- 6 dB/octave +1/-1.5 dB, 400-2700 Hz

12.5 kHz channel spacing:

- 6 dB/octave +1/-3 dB, 300-2500 Hz

Above 3000 Hz - 3-pole butterworth response -
fc= 3500 Hz

Non-deemphasised - gated

Flat +1/-3 dB, 50-3000 Hz

Above 3000 Hz - 3-pole butterworth response -
fc= 3500 Hz

Non-deemphasised - non-gated

Flat +1/-3 dB, 50-150 kHz

This output provides out-of-band noise signal
for diversity applications.

AUDIO NOISE LEVEL

Unsquelled

CQF9662: 50 dB
CQF9663: 50 dB
CQF9664: 44 dB

Squelched

CQF9662: 70 dB
CQF9663: 70 dB
CQF9664: 60 dB

SQUELCH ATTACK TIME

Slow squelch (audio path)

Threshold (critical setting) <200 ms
25 dB SINAD (fully tightened) <40 ms

Fast squelch (scanning applications)

Threshold +6 dB RF <5 ms
25 dB SINAD (fully tightened) <5 ms

SQUELCH RELEASE TIME

Slow squelch (audio path)

Threshold (critical setting) <300 ms
25 dB SINAD (fully tightened) <10 ms

Fast squelch (scanning applications)

Threshold +6 dB <5 ms
25 dB SINAD (fully tightened) <5 ms

CRITICAL SQUELCH SENSITIVITY

4.0 dB SINAD (25°C)

MAXIMUM SQUELCH SENSITIVITY

Greater than or equal to 20 dB quieting
Less than or equal to 1.5 uV RF input

SQUELCH BLOCKING

CQF9662: Greater than ± 5.0 kHz
CQF9663: Greater than ± 4.0 kHz (FTZ)
CQF9664: Greater than ± 2.5 kHz

DUTY CYCLE

Continuous

TRANSMITTER

FREQUENCY RANGE

403 - 470 MHz

POWER OUTPUT

Simplex, intermittent duty: 40/25/10 W
 Duplex, continuous duty: 25/18/6 W

CHANNEL SPACING

CQF9662: 25 kHz
 CQF9663: 20 kHz
 CQF9664: 12.5 kHz

LOAD IMPEDANCE

50 ohm

FREQUENCY STABILITY

± 2 ppm

POWER ADJUSTMENT RANGE

Adjustable 3:1

MAX. TRANSMITTER CHANNEL BANDWIDTH

OPERATING MODE	FULL SPECIFICATIONS		3 dB DEGRADATION ⁺	
	SYNTHESIZER	MULTIPLIER	SYNTHESIZER	MULTIPLIER
SIMPLEX	5.0 MHz	5.0 MHz	5.0 MHz	6.0 MHz
DUPLEX 4.5 MHz	0.8 MHz	0.8 MHz	1.2 MHz	1.0 MHz
DUPLEX 6 MHz	1.3 MHz	1.3 MHz	1.8 MHz	1.8 MHz
DUPLEX 8 MHz	2.0 MHz	2.0 MHz	2.0 MHz	3.0 MHz
DUPLEX 10-15 MHz	2.5 MHz	2.5 MHz	3.5 MHz	3.5 MHz

⁺Degradation with respect to output power

DUPLEX SPACING

4.5 MHz to 12 MHz

ADJACENT CHANNEL POWER

EIA/CEPT/SWEDEN
 20 - 25 kHz: -70 dB
 12.5 kHz: -60 dB

PA PROTECTION TO LOAD VARIATION

No damage for 0 to ∞ impedance loads and all phase angles.

MAXIMUM FREQUENCY DEVIATION

25 kHz Channel spacing:
 EIA/CEPT max. ± 5 kHz
 FTZ max. ± 4 kHz

20 kHz Channel spacing:
 EIA max. ± 4 kHz

12.5 kHz Channel spacing:
 CEPT max. ± 2.5 kHz

AUDIO SENSITIVITY FOR RATED DEVIATION (1000 Hz)

100 mV ± 3 dB (EIA/CEPT)

CHANNEL GUARD INPUT

300 mV ± 3 dB at 100 Hz, 10% Δf max.

CONDUCTED SPURIOUS (EIA/CEPT)

Harmonics: 0.25 μ W
 Other: 0.20 μ W

RADIATED SPURIOUS EIA/CEPT

0.20 μ W

FM HUM AND NOISE (EIA/CEPT)

	Multiplier	Synthesizer
25 kHz channel spacing:	-60 dB	-50 dB
20 kHz channel spacing:	-60 dB	-50 dB
12.5 kHz channel spacing:	-50 dB	-45 dB

AM HUM AND NOISE (EIA)

-50 dB

AUDIO FREQUENCY CHARACTERISTICS

Speech processed input

- Impedance 600 ohm $\pm 20\%$ - transformer coupled
 - floating.
- Response 6 dB/octave +1/-3 dB - 300 to 3000 Hz
- Response 6 dB/octave +1/-1.5 dB - 400 to 2700 Hz
 The above applies in 20 and 25 kHz channel spacing systems.
- Response 6 dB/octave +0.5/-3 dB - 300 to 2500 Hz
 The above applies in 12.5 kHz channel spacing systems.

Channel Guard input

- Impedance adjustment dependent > 5.6 Kohm.
- DC level approx. 4.5 V.
- Response flat ± 1 dB from 50 to 250 Hz.

AUDIO DISTORTION

Less than 5% (1000 Hz, 60% modulation)

TRANSMIT ATTACK TIME

5 ms

TRANSMIT DECAY TIME

5 ms

CHAPTER
CHAPITRE
KAPITEL

3

Storno

CQF9000

PRESENTATION

Example of module combination in a base station CQF9xxx

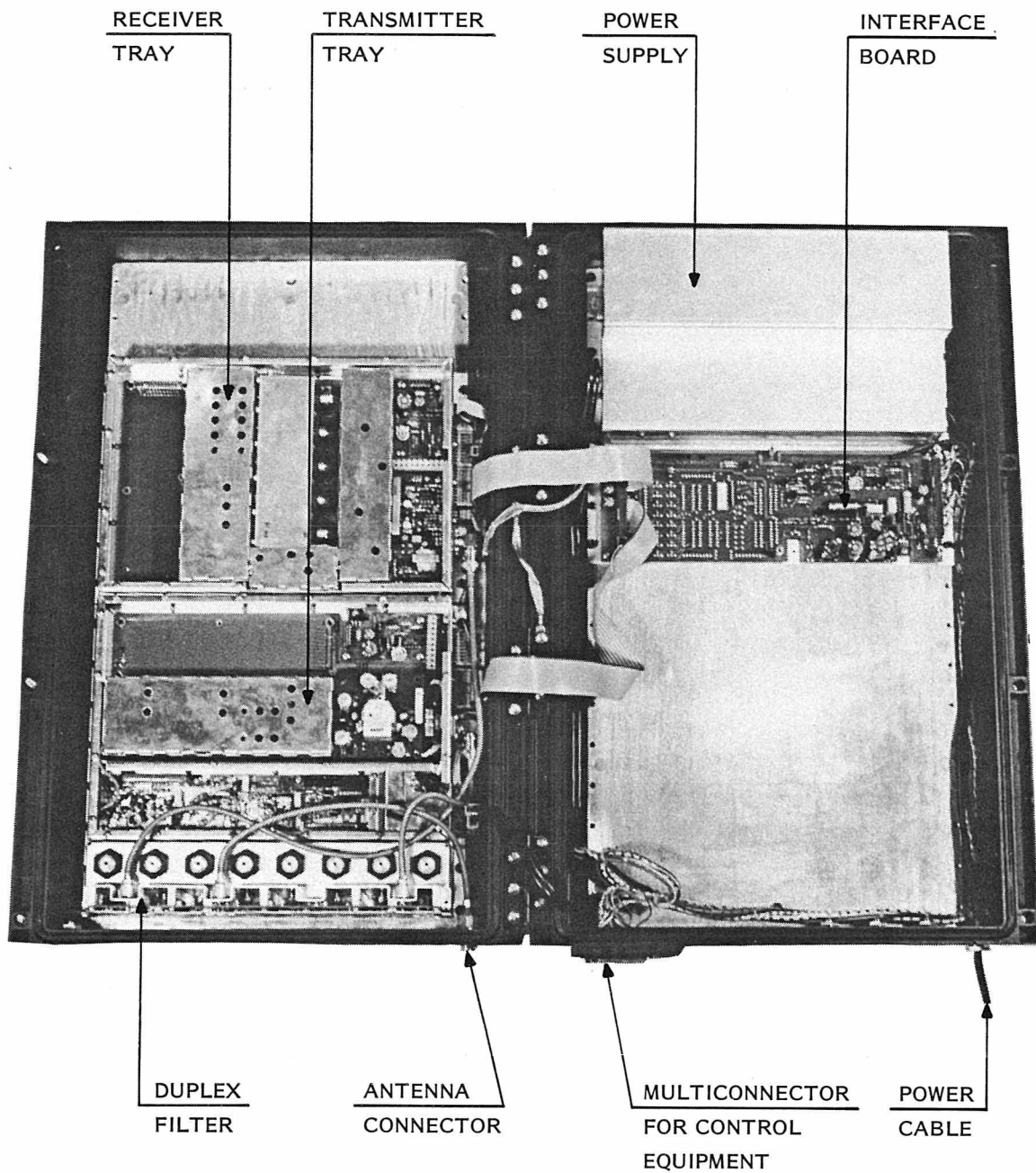

GENERAL DESCRIPTION

CQF9000

INTRODUCTION

The CQF9000 base station is a transmitter/receiver of modular construction for wide applications in radio telephone systems. The base station is built from the range modules used in the mobile M900 series and covers the various frequency bands allocated for mobile radiotelephone service.

The radio can be operated in either duplex or simplex and is available for 25 kHz, 20 kHz and 12.5 kHz channel spacing. The transmitter RF power output can be in the range 6 to 40 watts depending on the type of power module in the transmitter.

The radio station is powered from a 220 V AC or 110 V AC supply, a 18-36 V DC or 38-72 V DC supply, or optional by an external DC power source.

Various types of control equipment of the CAF600 and the CAF9000 series can be used when the radio is fitted with an interface unit or it may be operated as an unattended repeater station.

The receiver and transmitter units of the radio telephone are built into a die cast cabinet which consists of two sections hinged together for easy access. The cabinet is locked with four screws and a rubber packing which secure a tight and splashproof construction.

The cabinet surface has ribs in order to act as heat sink and the bottom has a number of cable entries for connection of antenna, power supply and control equipment.

These cable entries are all packed to be water-tight.

The cabinet is designed for mounting on a wall or in a rack by means of a support.

The interior of the cabinet provides space for the transmitter unit, the receiver unit, the power supply module, the antenna switch module or the duplex filter, the interface module and various control equipment circuits.

The transmitter and the receiver are completely screened boxes which connect to the power supply, the antenna switch or duplex filter and the interface module by means of a set of flat cables and the RF signals by coax cables. The receivers and transmitters can be either synthesizer versions or multiplier versions depending on the required number of channels, the spectral purity, the RF bandwidth or other requirements.

Both the receiver box and the transmitter box contains a number of modules mounted on a motherboard which provides the interconnection of modules except for RF signals which are by means of coaxial cables with plugs and sockets. This concept facilitates easy service in case of a faulty module.

ELECTRICAL DESIGN

The receiver and transmitter modules are built on printed wiring boards which plug into a motherboard in the bottom of the box. Each module is fastened with screws and, if necessary, has its own screen box.

Central metering connectors are provided for easy testing and adjustment of the units.

Both transmitters and receivers are available with two types of channel frequency generation, synthesizer and multiplier versions.

GENERAL DESCRIPTION, CQF9000

The synthesizer version can generate up to 256 contiguous channels of which 12 can be selected by programming a prom (programmable read only memory) placed on the interface module. The control equipment is capable of switching between the selected channels.

The multiplier versions have provision for a number of channels as follows:

<u>TYPE</u>	<u>BAND</u>	<u>RX CH</u>	<u>TX CH</u>
CQF933x	68-88 MHz	5	3
CQF911x	146-174 MHz	5	3
CQF955x	370-410 MHz	NOT AVAILABLE	
CQF966x	403-470 MHz	3	2

Both synthesizer and multiplier versions are available for 12.5 kHz, 20 kHz and 25 kHz channel spacing.

For the 68-88 MHz, the 146-174 MHz and the 403-470 MHz band two types of receiver front ends are available:

- High sensitivity front end
- High intermodulation attenuation front end.

The high sensitivity front end can only be used in simplex applications.

The maximum RF bandwidth is limited to that of the receiver front end and the transmitter power amplifier/exciter or in duplex applications the duplex filter.

The radio station is powered by 110/220 V AC mains, a 18-36 V DC or 38-72 V DC supply or 12/24 V DC and in all cases the power supply module is built into the cabinet. For DC operation an external power source, either a battery or a DC power supply, is necessary and the maximum RF power output is limited to 25 W simplex and 18 W duplex.

RECEIVER

The receiver is a dual conversion heterodyne receiver housed in a screened box with connectors that connect to the rest of the radio station circuits.

The receiver modules depend on the versions which are:

<u>MULTIPLIER</u>	<u>SYNTHESIZER</u>
Receiver Converter	Receiver Converter
Channel generator	Phase locked loop
IF amplifier	Channel synthesizer
AF Line amplifier	IF amplifier
Voltage regulator	AF lime amplifier
	Voltage regulator

Detailed descriptions of each module are found in a separate manual.

The receiver is supplied from +12 V DC which is regulated to +9 V internally by a voltage regulator.

The antenna signal from the antenna is applied to the receiver via the antenna switch or the duplex filter. The demodulated AF signal from the receiver is applied to the interface unit and to the control equipment.

TRANSMITTER

The transmitter is phase modulated and housed in a screened box with connectors that connect to the interface and power supply units.

The transmitter modules depend on the versions which are:

<u>MULTIPLIER</u>	<u>SYNTHESIZER</u>
Channel generator	Channel synthesizer
Power amplifier	Exciter
Voltage regulator	Power amplifier
	Voltage regulator

The transmitter is, except for the power amplifier, supplied from +12 V which is regulated internally to +9 V by a voltage regulator. The power amplifier is directly supplied from +12 V.

The transmitter RF output is applied to the antenna switch or the duplex filter and the modulation is coming from the control equipment.

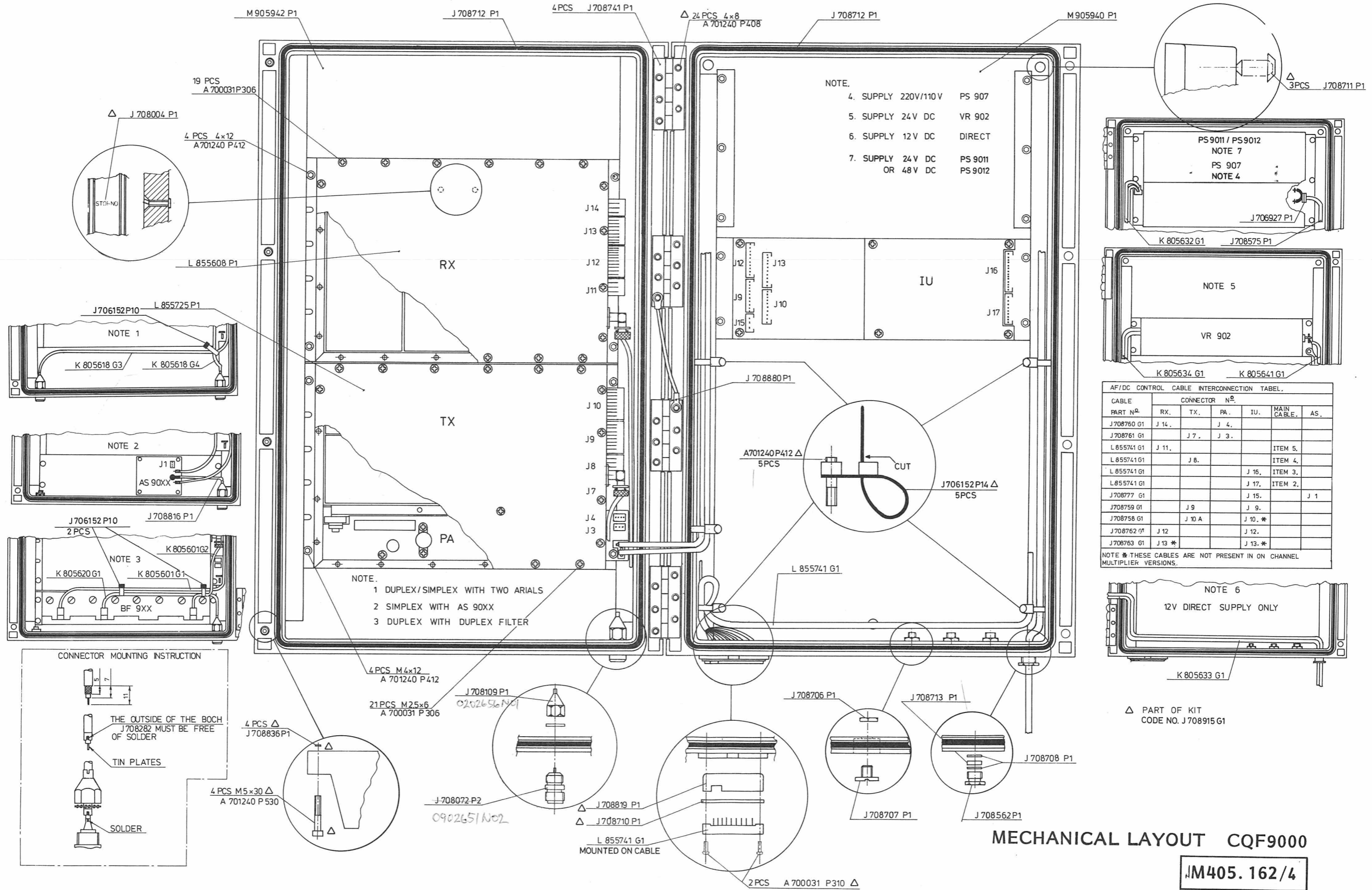

- NOTE.
- 4. SUPPLY 220V/110 V PS 907
 - 5. SUPPLY 24V DC VR 902
 - 6. SUPPLY 12V DC DIRECT
 - 7. SUPPLY 24V DC PS 9011 OR 48V DC PS 9012

AF/DC CONTROL CABLE INTERCONNECTION TABLE.

CABLE PART N ^o	CONNECTOR N ^o				
	RX.	TX.	PA.	IU.	MAIN CABLE. AS.
J708760 G1	J 14.			J 4.	
J708761 G1		J 7.		J 3.	
L 855741 G1	J 11.				ITEM 5.
L 855741 G1		J 8.			ITEM 4.
L 855741 G1				J 16.	ITEM 3.
L 855741 G1				J 17.	ITEM 2.
J708777 G1				J 15.	J 1
J708759 G1		J 9		J 9.	
J708758 G1		J 10 A		J 10.*	
J708762 G1		J 12		J 12.	
J708763 G1		J 13 *		J 13.*	

NOTE * THESE CABLES ARE NOT PRESENT IN ON CHANNEL MULTIPLIER VERSIONS.

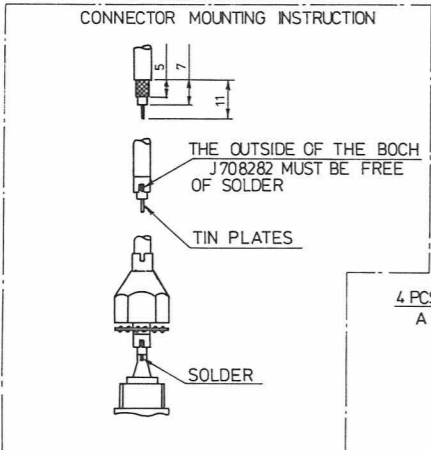
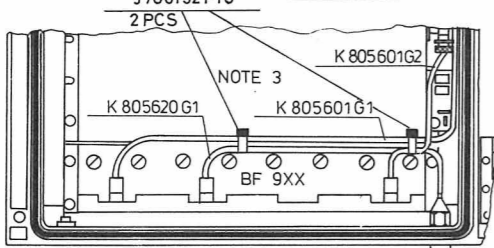
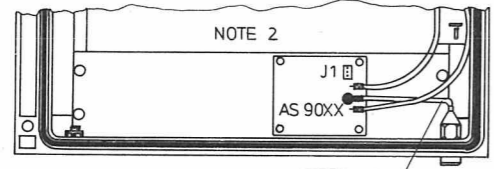
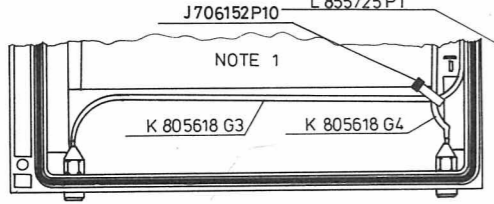
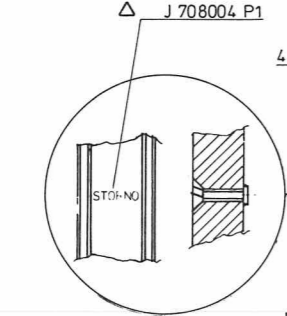

- NOTE.
- 1 DUPLEX/SIMPLEX WITH TWO ARIALS
 - 2 SIMPLEX WITH AS 90XX
 - 3 DUPLEX WITH DUPLEX FILTER

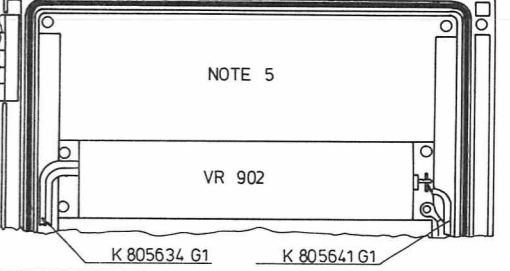
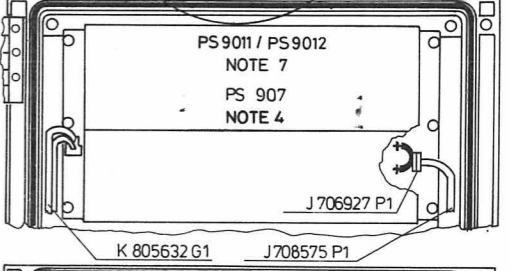
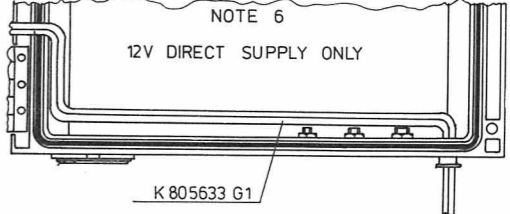

Δ PART OF KIT CODE NO. J708915 G1

RECEIVER

MULTIPLIER VERSION

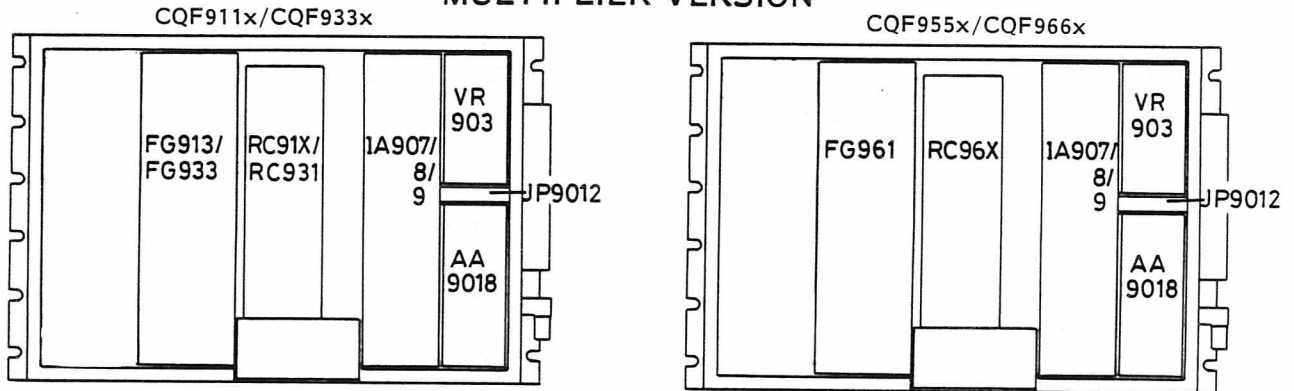

IF AMPLIFIER MODULE	CHANNEL SPACING
IA907	25.0 kHz
IA908	20.0 kHz
IA909	12.5 kHz

RX CONVERTER MODULE	HIGH INTERMODULATION ATT.	HIGH SENSITIVITY (ONLY SIMPLEX)
RC911	X	
RC912		X
RC931	X	
RC953	X	
RC969	X	
RC962		X

SYNTHESIZER VERSION

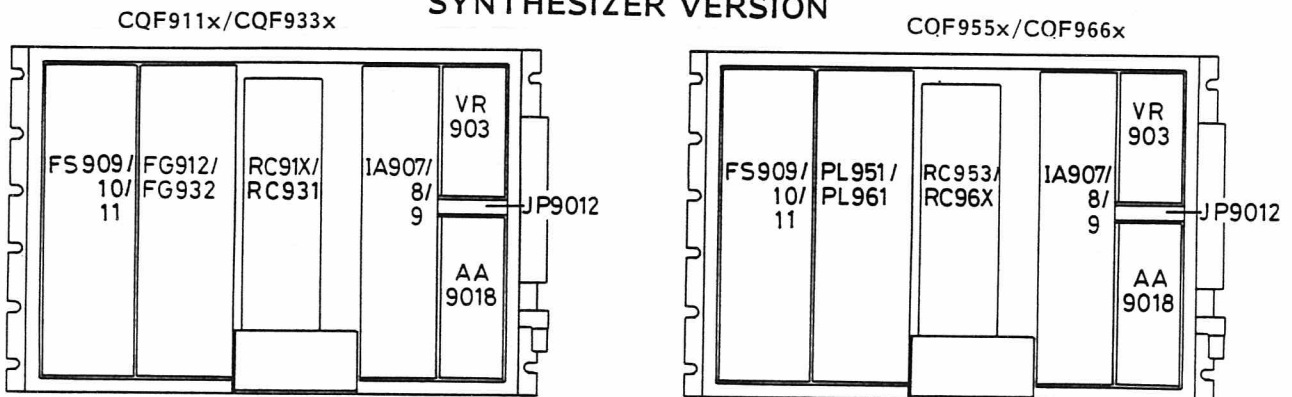

FREQ. SYNTH. MODULE	CHANNEL SPACING
FS909	12.5 kHz
FS9010	20.0 kHz
FS9011	25.0 kHz

TRANSMITTER

MULTIPLIER VERSION

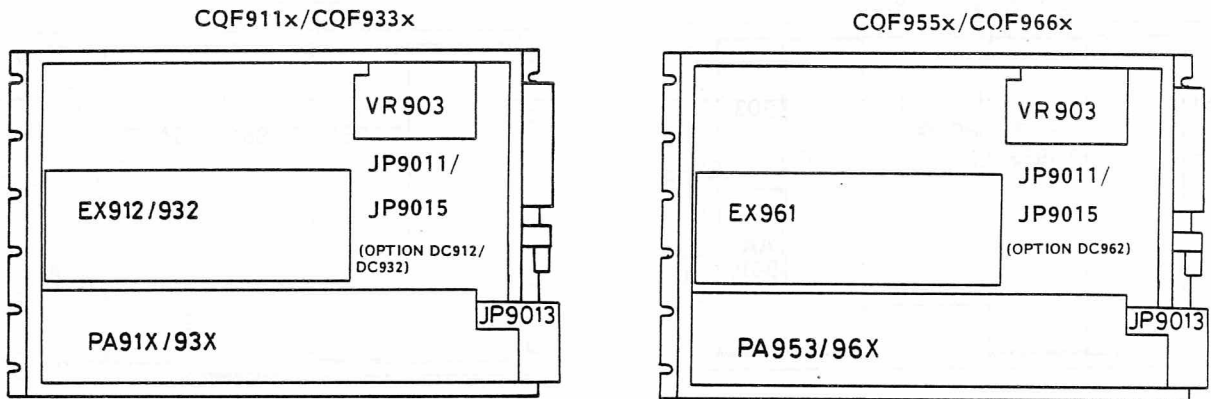

POWER AMP. MODULE	FREQUENCY RANGE	POWER OUTPUT SIMPLEX		POWER OUTPUT DUPLEX	
		without DC	with DC	without DC	with DC
PA911	138-174 MHz	10 W	10 W	6 W	6 W
PA913		25/40 W	25 W	18 W	18 W
PA931	66-88 MHz	10 W	10 W	6 W	6 W
PA932		25 W	25 W	18 W	18 W
PA933		40 W	25 W	25 W	18 W
PA953	350-410 MHz	40 W		25 W	
PA961	403-470 MHz	10 W	10 W	6 W	6 W
PA962		25 W	25 W	18 W	18 W
PA963		40 W	25 W	25 W	18 W

SYNTHESIZER VERSION

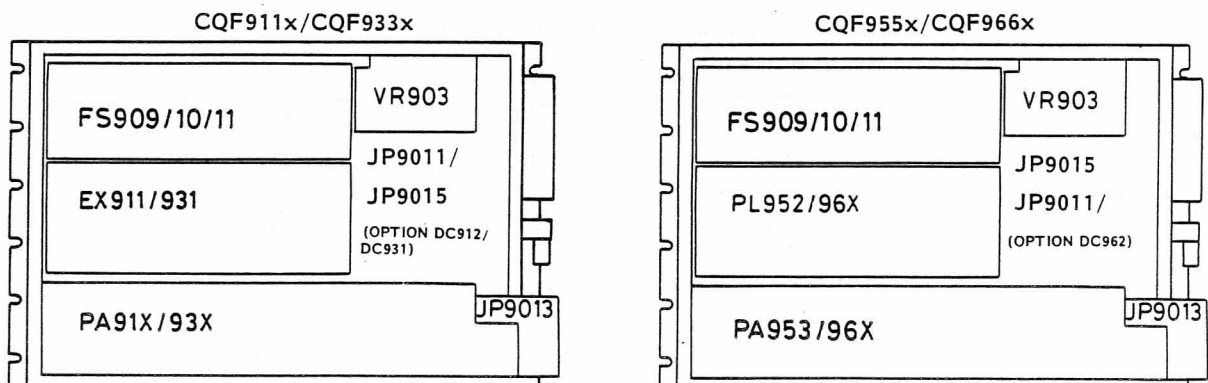

FREQ. SYNTH. MODULE	CHANNEL SPACING
FS909	12.5 kHz
FS9010	20.0 kHz
FS9011	25.0 kHz

Storno

Storno

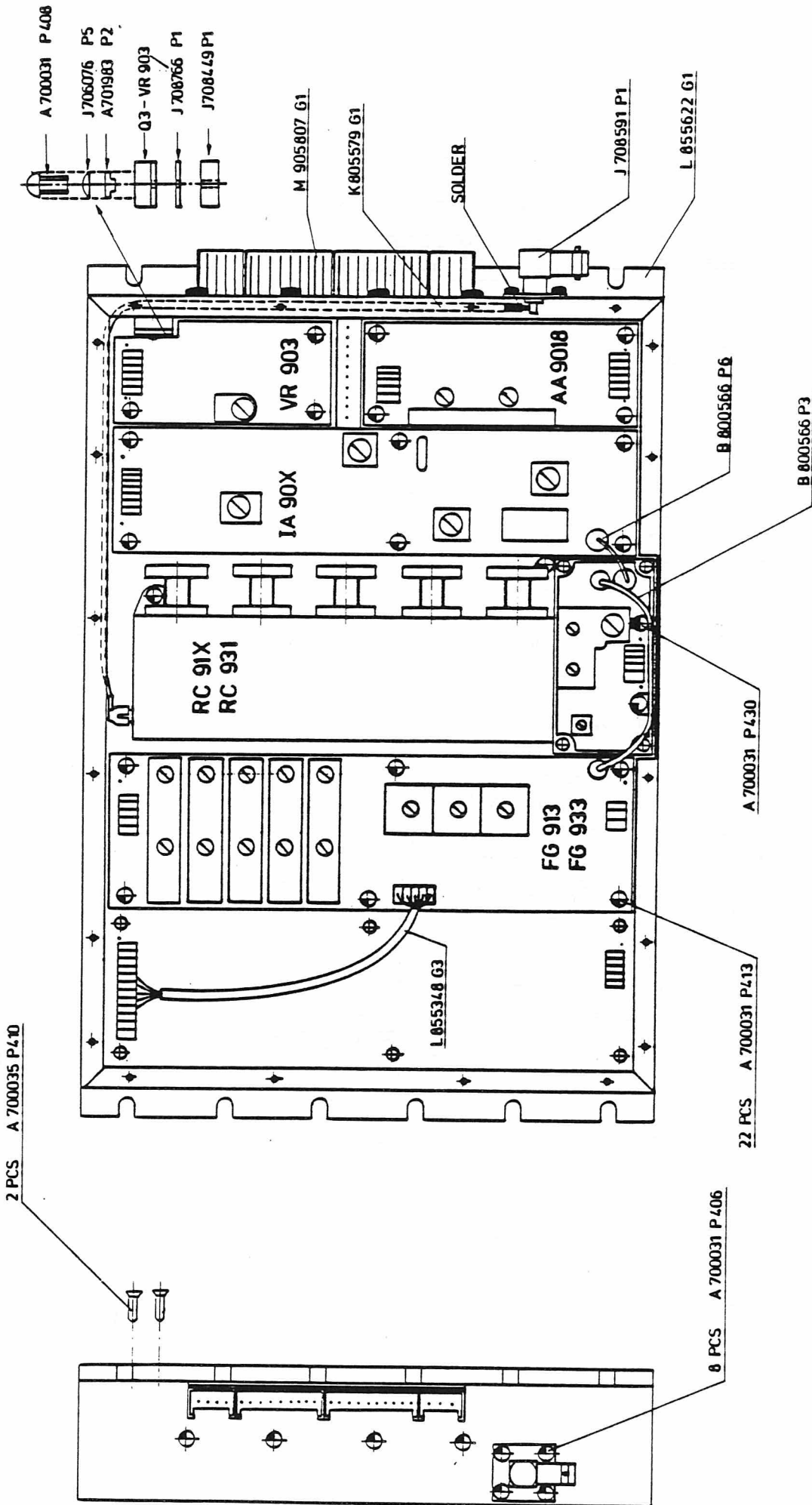

MECHANICAL LAYOUT & PART NUMBERS
CQF9110/9330 MULTIPLIER RECEIVER

M405.184/2

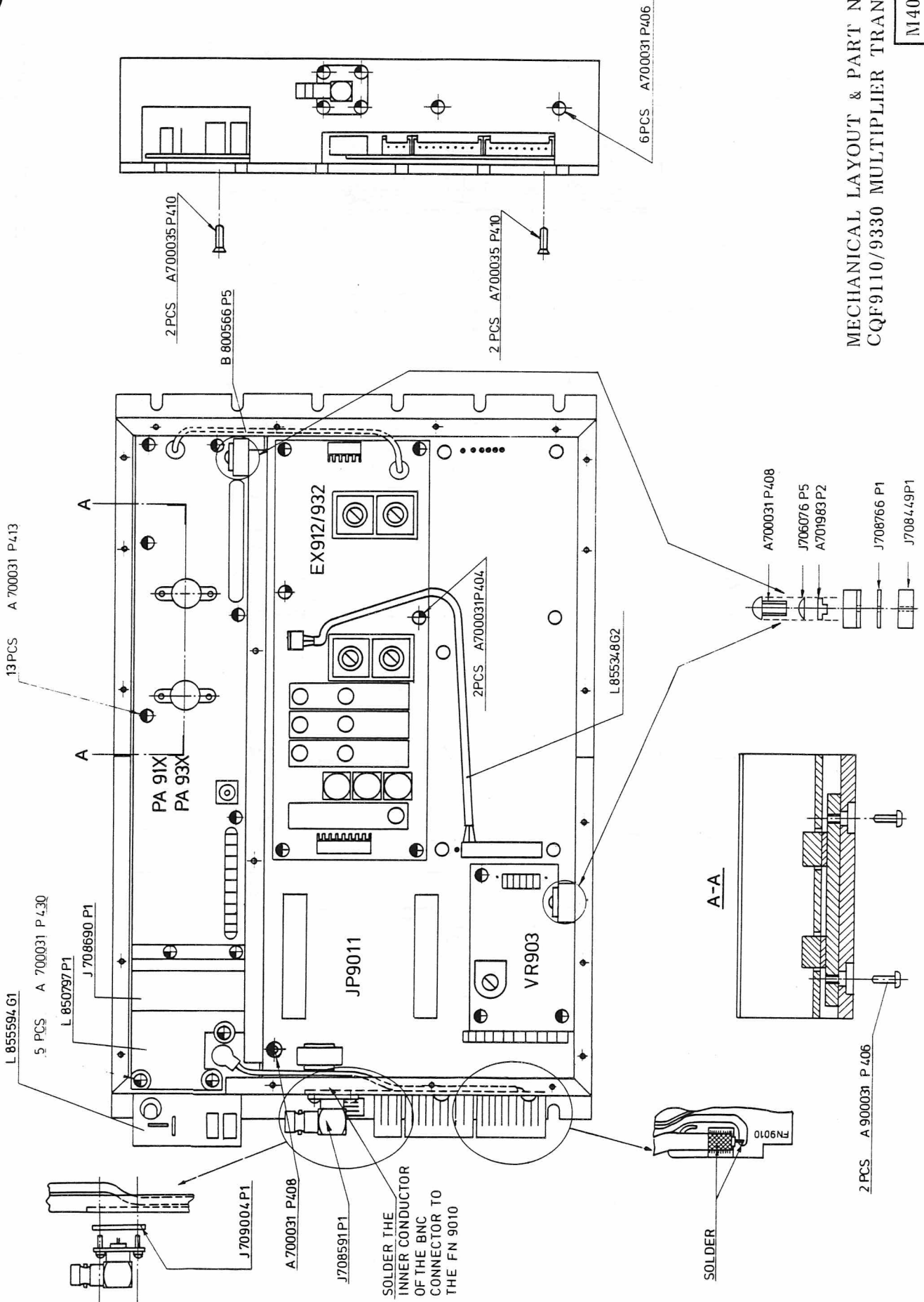

MECHANICAL LAYOUT & PART NUMBERS
 CQF9110/9330 MULTIPLIER TRANSMITTER

Storno

Storno

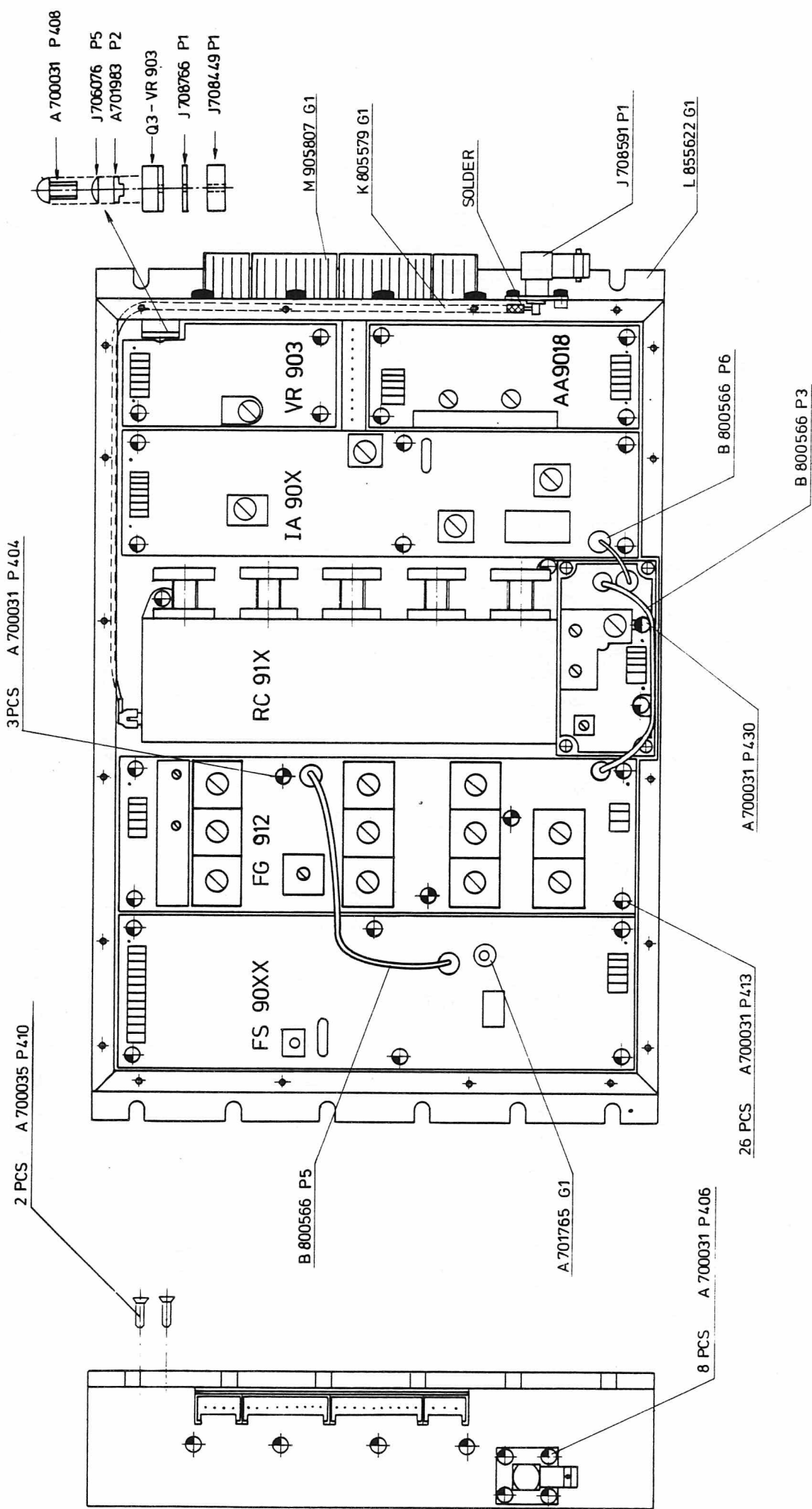

MECHANICAL LAYOUT & PART NUMBERS
CQF9110 SYNTHESIZER RECEIVER

M405.182

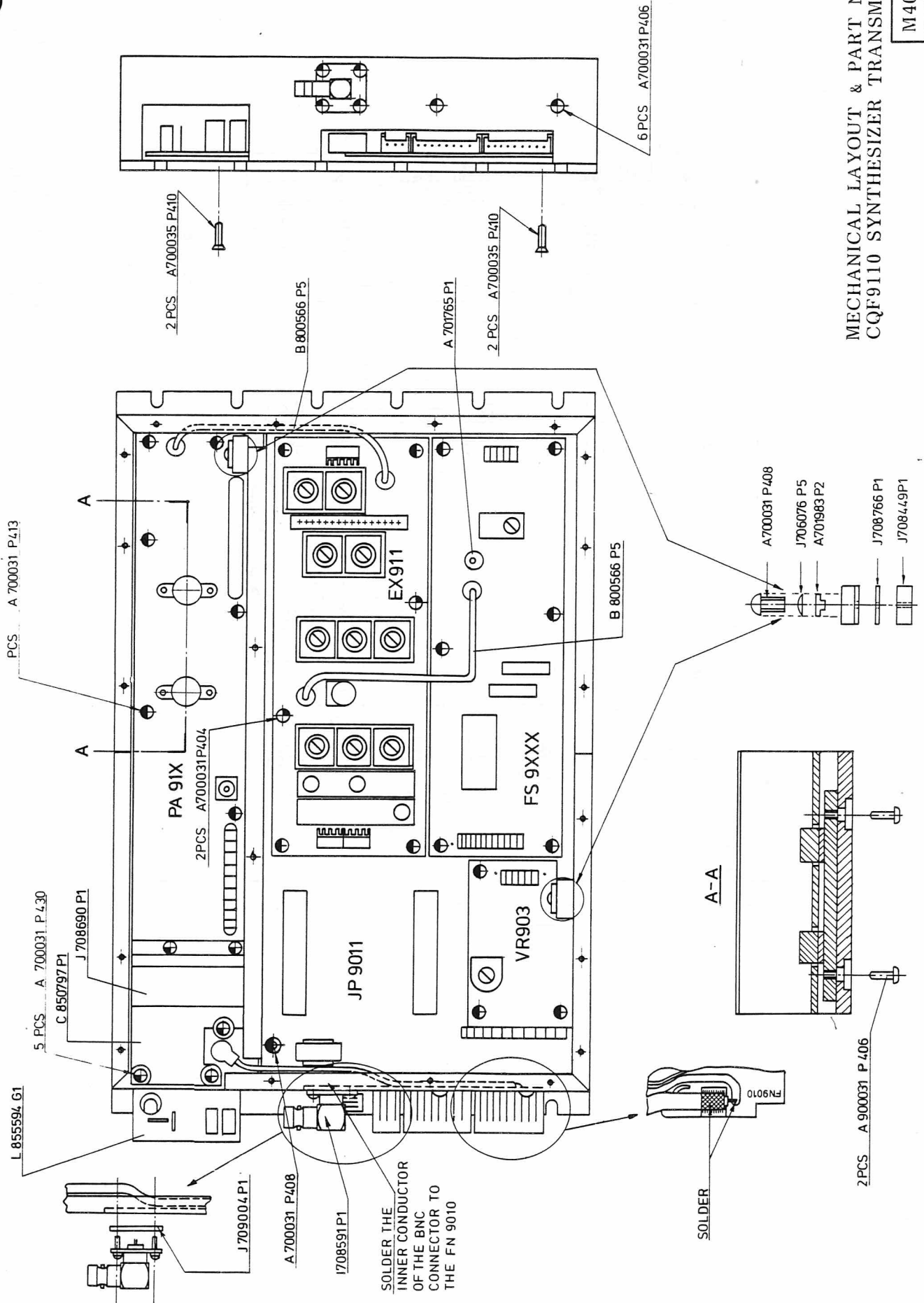

MECHANICAL LAYOUT & PART NUMBERS
CQF9110 SYNTHESIZER TRANSMITTER

M405.181/2

Storno

Storno

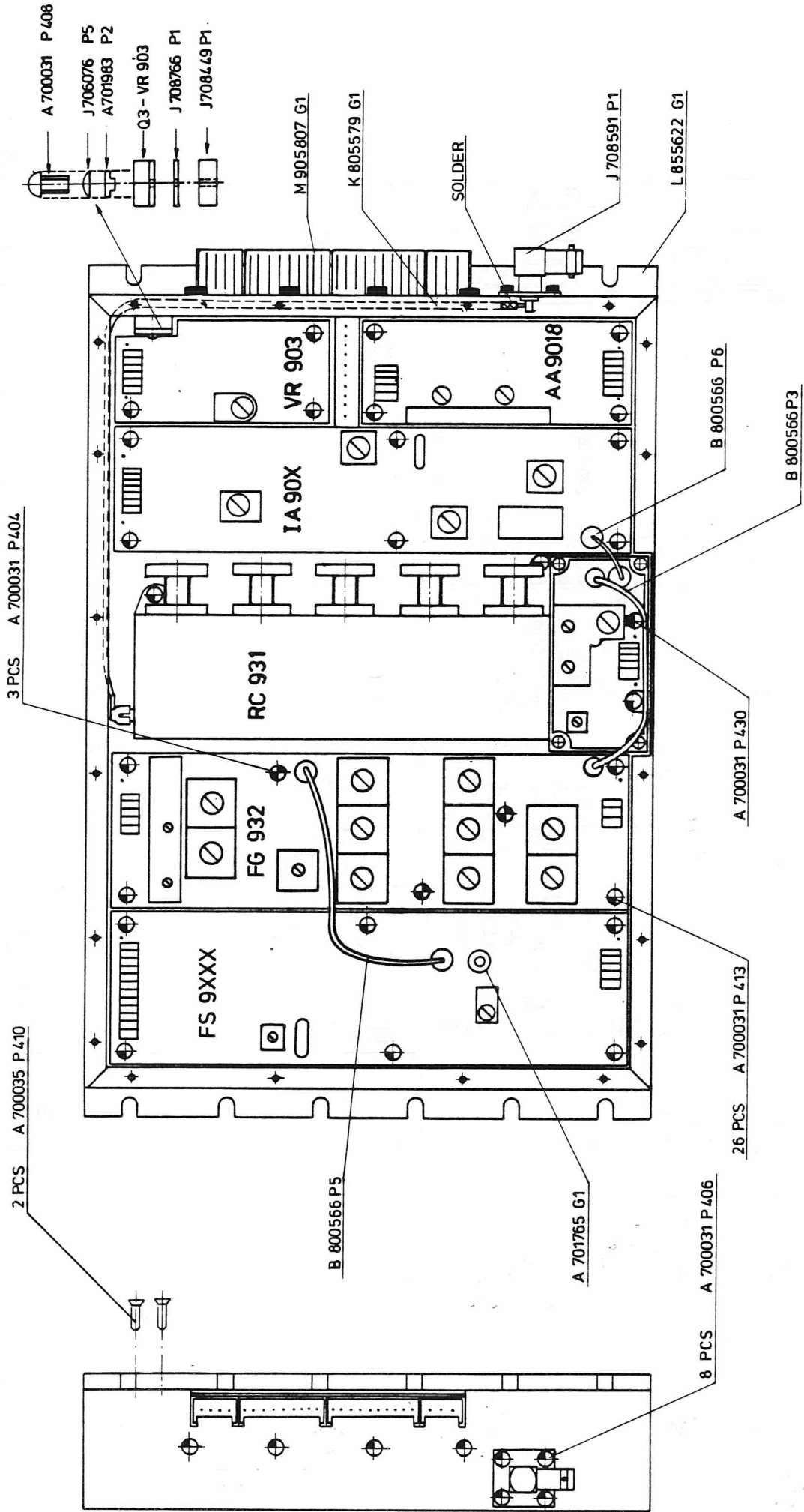

MECHANICAL LAYOUT & PART NUMBERS
CQF9330 SYNTHESIZER RECEIVER

M405.18612

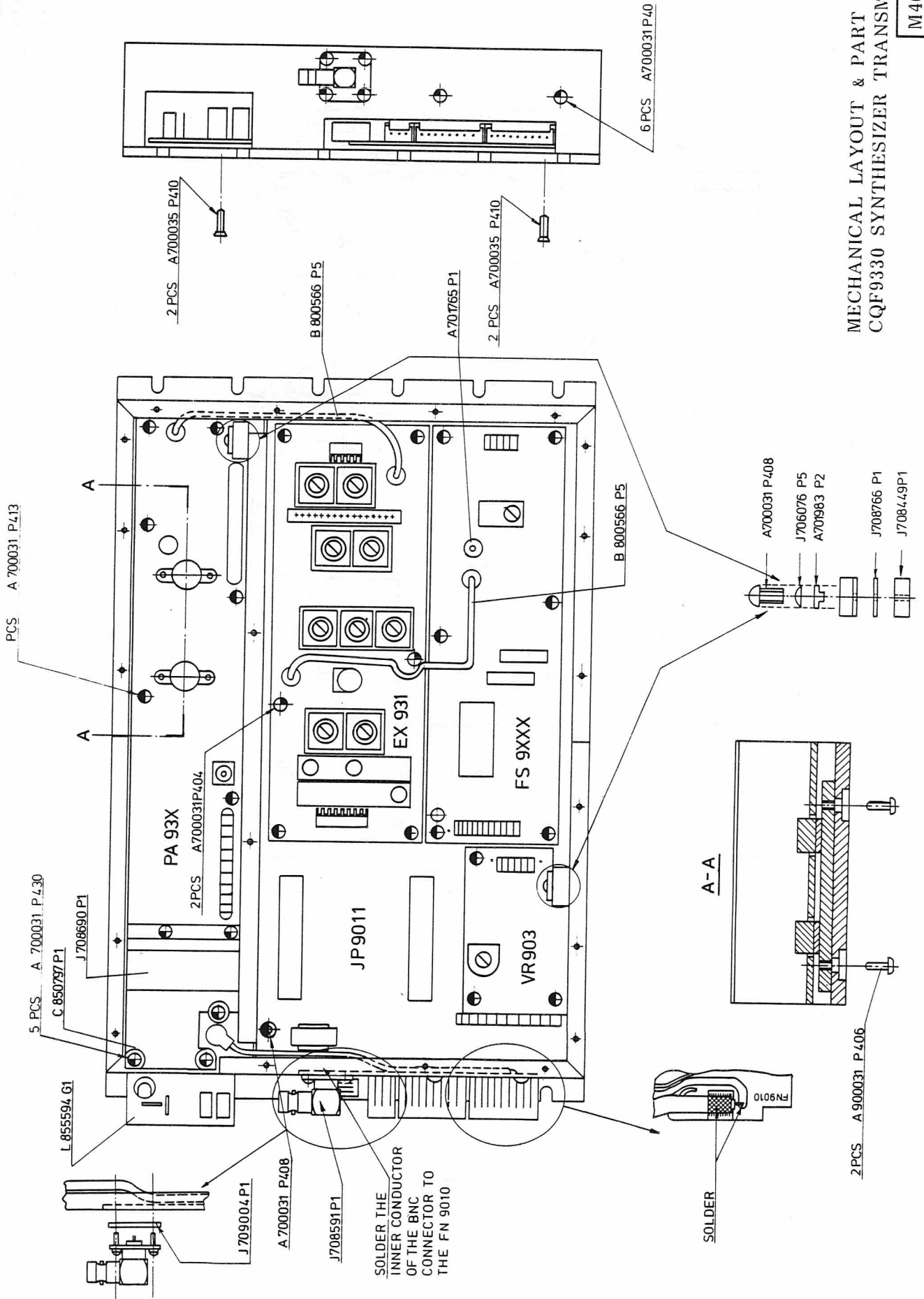

MECHANICAL LAYOUT & PART NUMBERS
CQF9330 SYNTHESIZER TRANSMITTER

M405.185 / 2

Storno

Storno

2 PCS A 700035 P 410

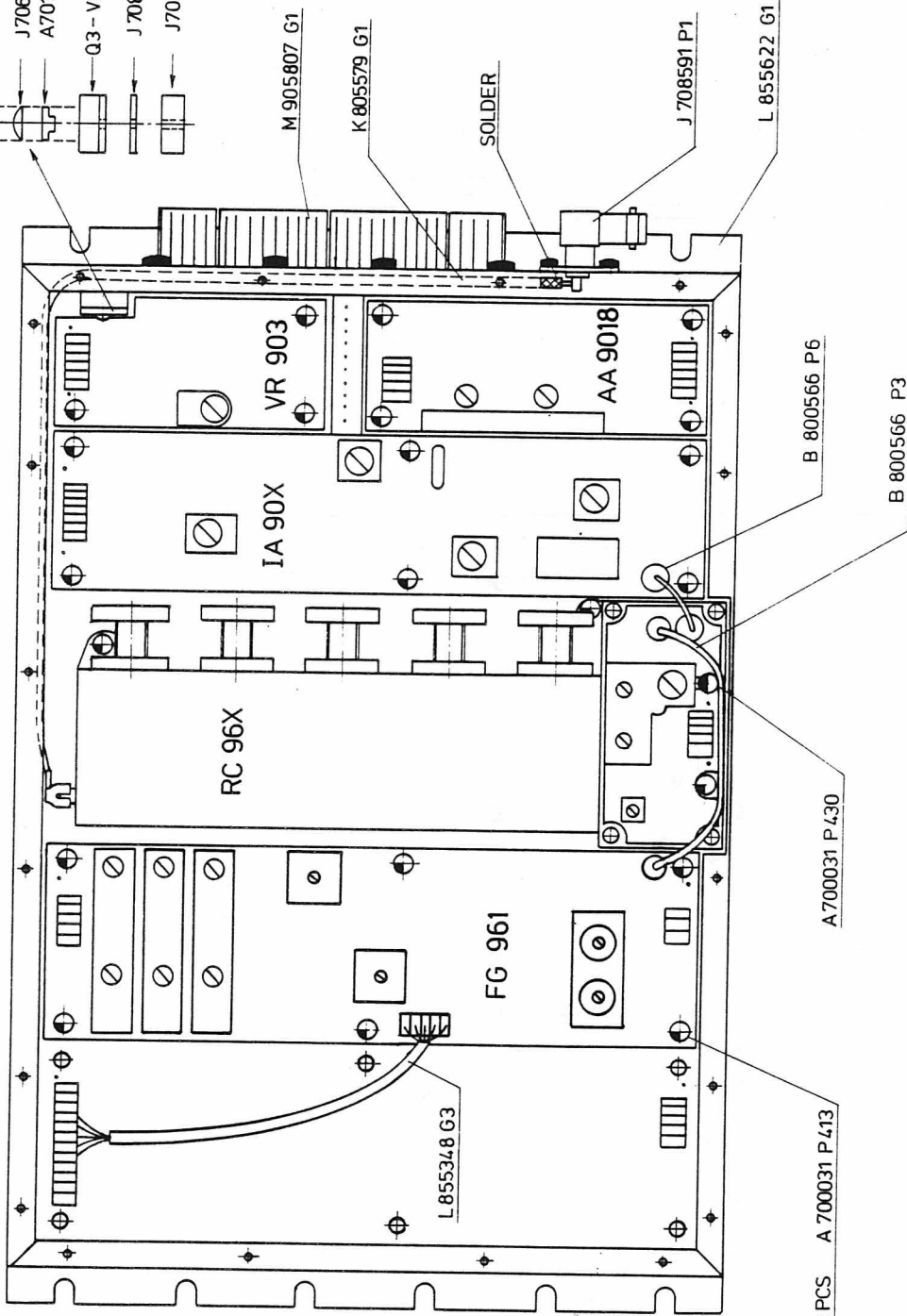
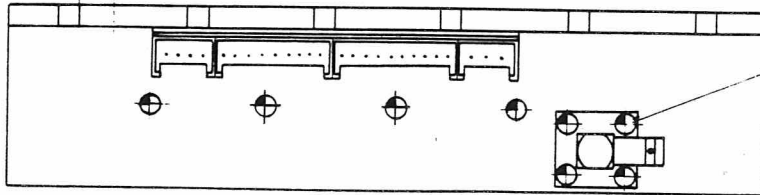
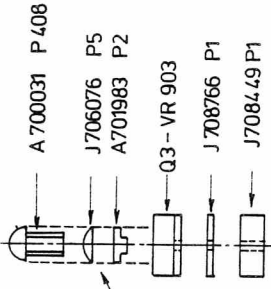

22 PCS A 700031 P 413

8 PCS A 700031 P 406

MECHANICAL LAYOUT & PART NUMBERS
CQF9660 MULTIPLIER RECEIVER

M405.190

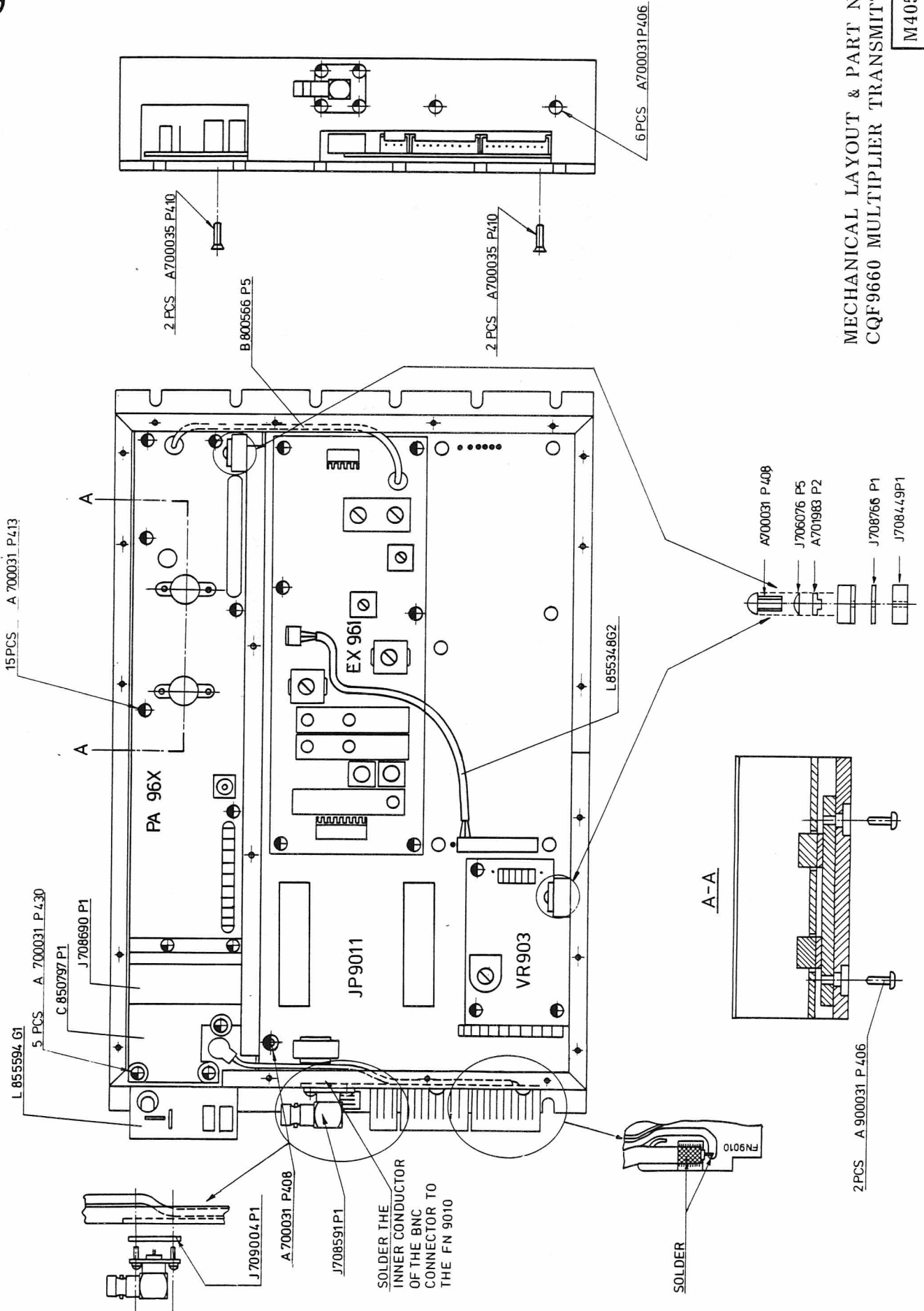

MECHANICAL LAYOUT & PART NUMBERS
CQF9660 MULTIPLIER TRANSMITTER

M405.189 /2

Storno

Storno

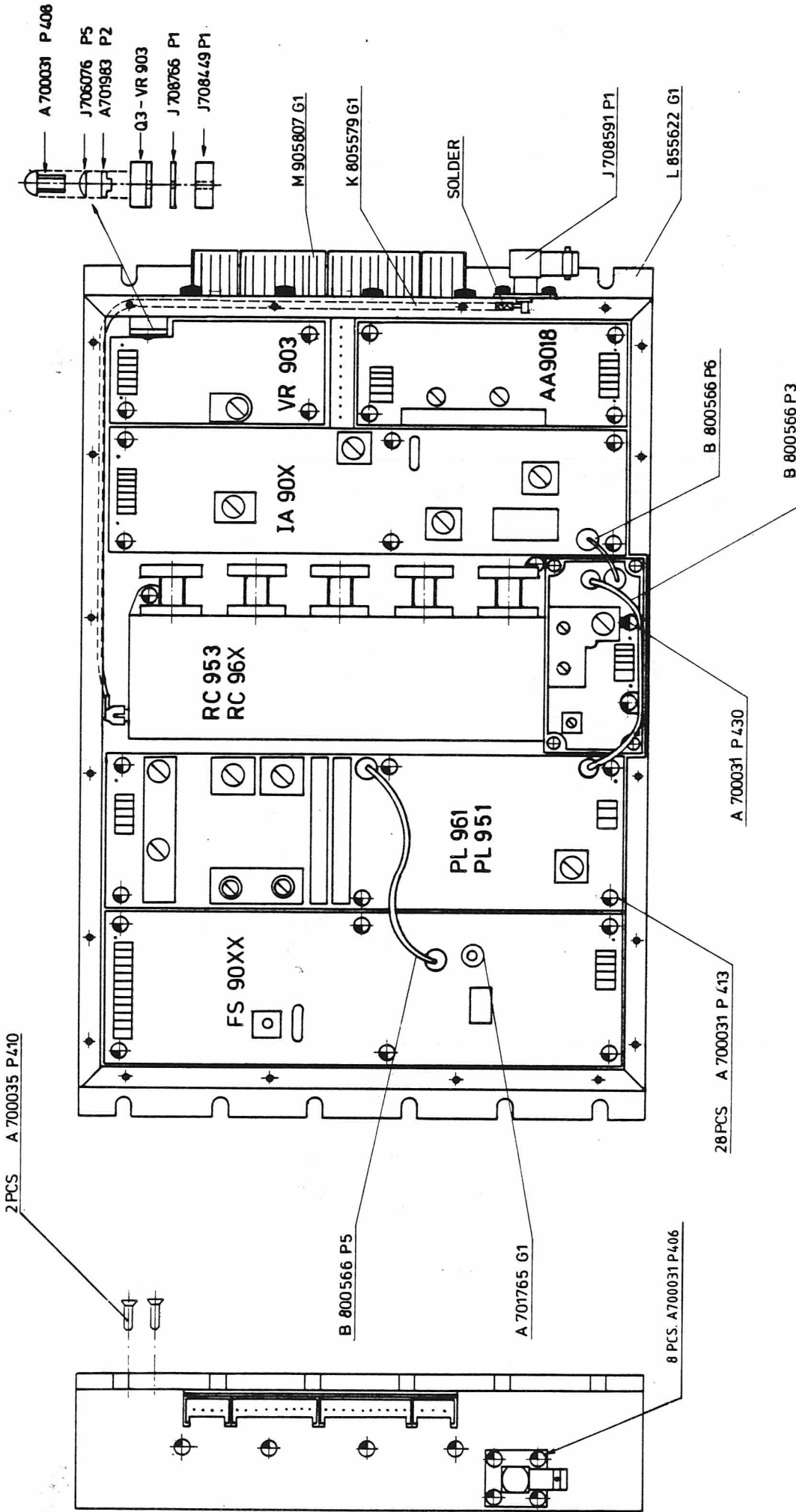

MECHANICAL LAYOUT & PART NUMBERS
CQF9660 / 9550 SYNTHESIZER RECEIVER

M405.188/2

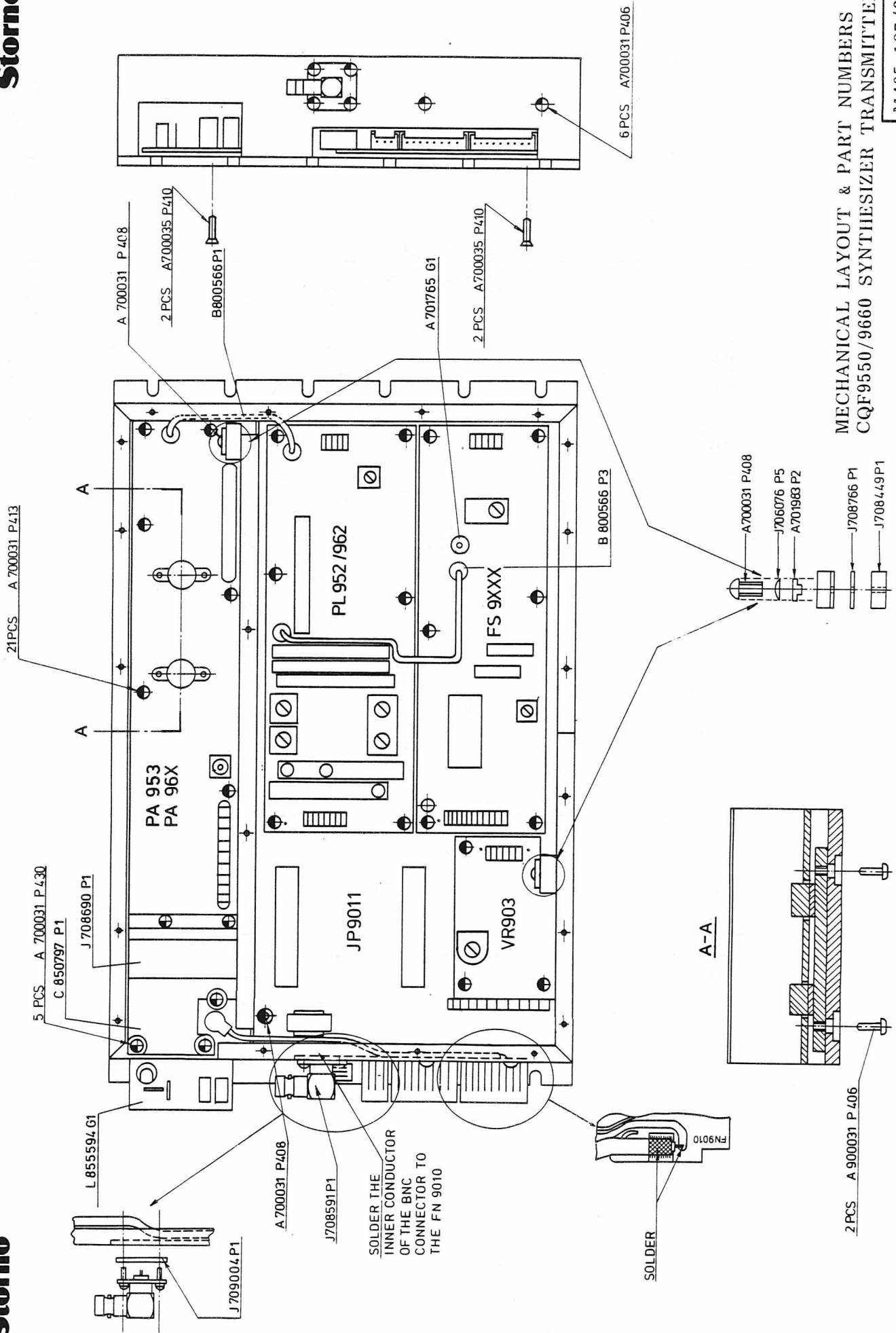

MECHANICAL LAYOUT & PART NUMBERS
CQF9550/9660 SYNTHESIZER TRANSMITTER

M405. 187/3

Storno

Storno

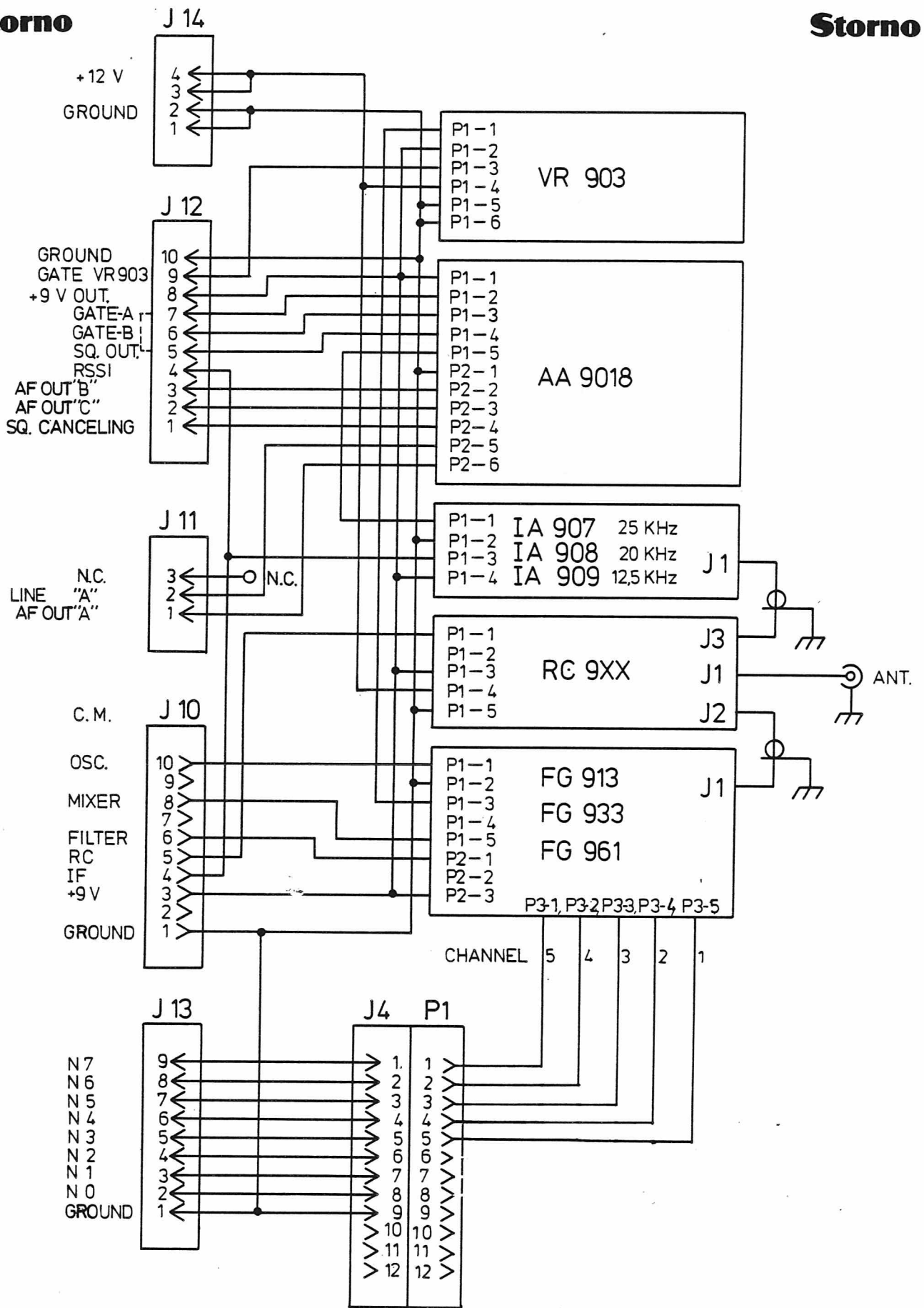

INTERCONNECTION DIAGRAM CQF9XXX
RECEIVER WITH MULTIPLIER

D403.902/2

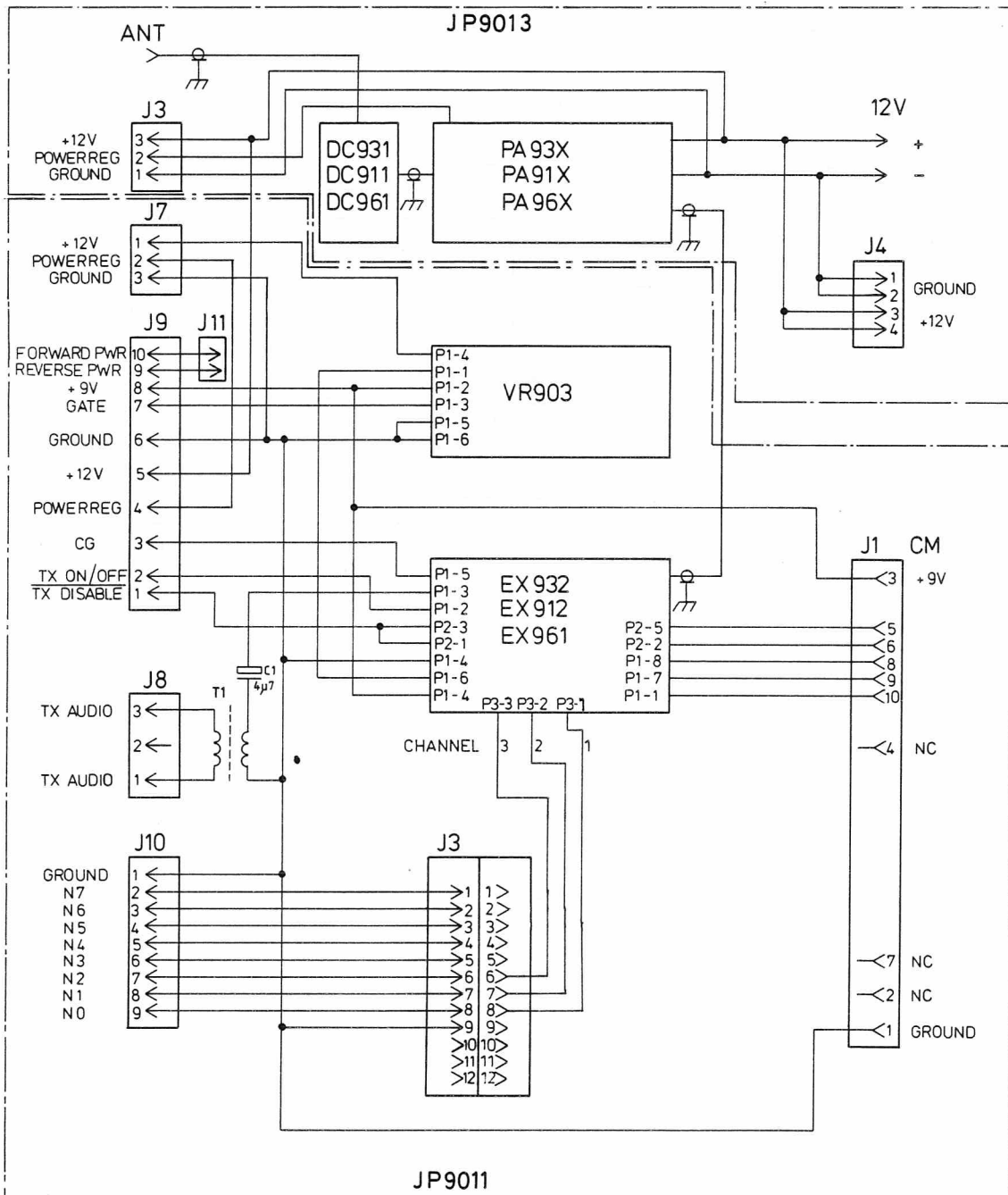

CM					
PIN	5	6	8	9	10
EX932	NC	BP2	NC	NC	OSC
EX912	NC	BP2	NC	NC	OSC
EX961	NC	TRIBLER	NC	NC	OSC

INTERCONNECTION DIAGRAM CQF9XXX
TRANSMITTER WITH MULTIPLIER

D403.904

Storno

Storno

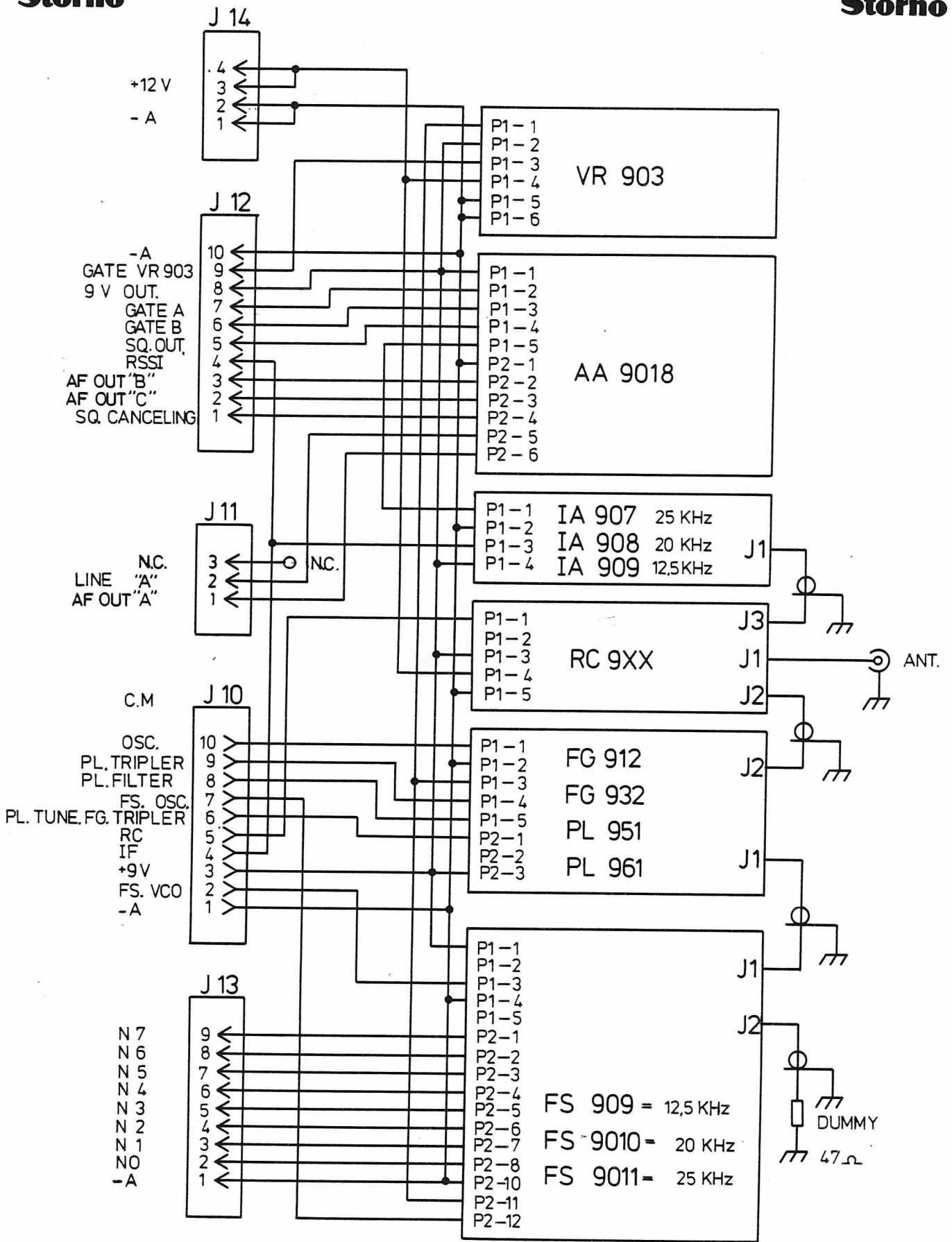

INTERCONNECTION DIAGRAM CQF9XXX
RECEIVER WITH SYNTHESIZER

D403.901/2

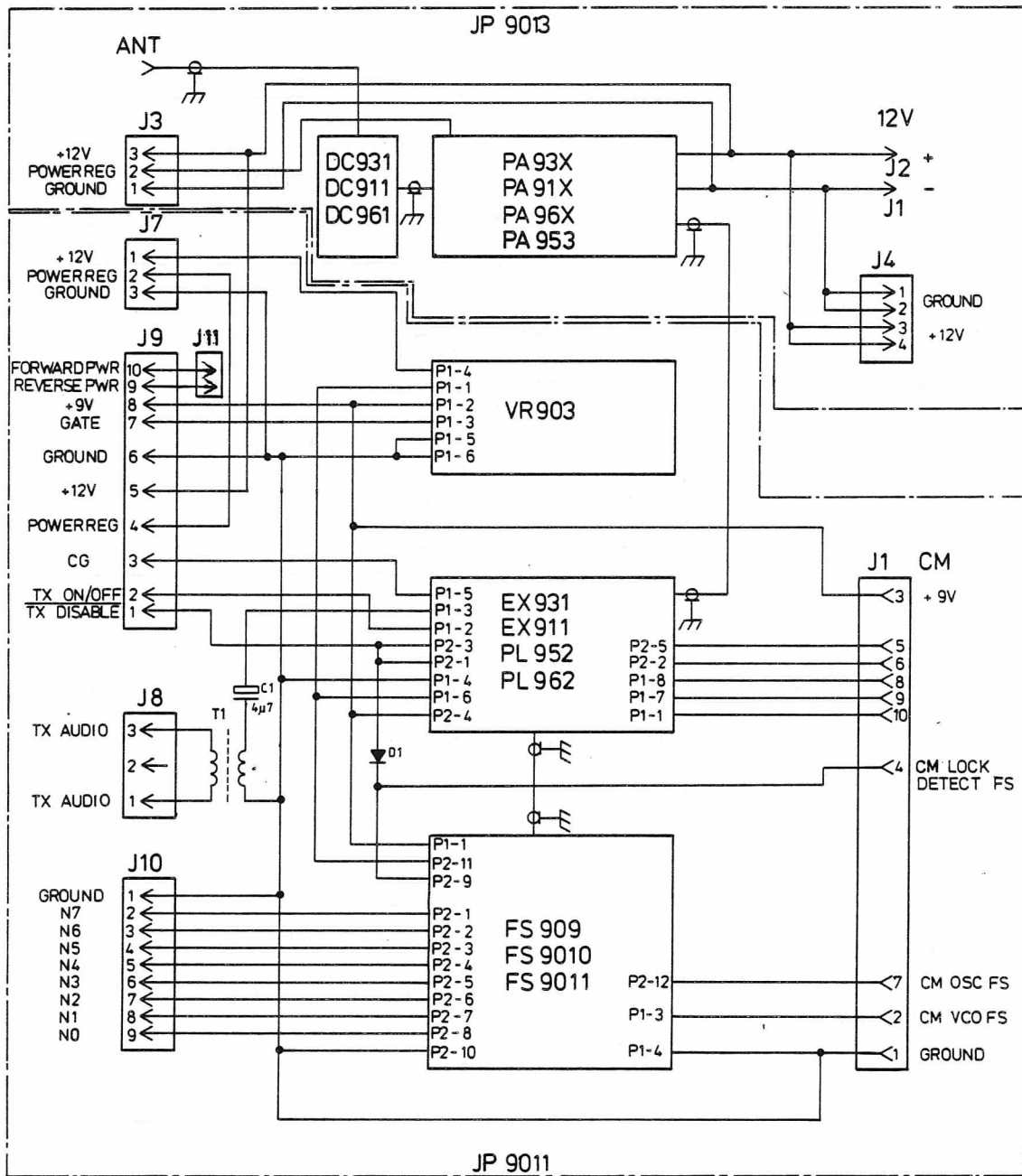

CM					
PIN	5	6	8	9	10
EX931	BP1	BP2	NC	MIXER	OSC
E911	BP1	BP2	NC	MIXER	OSC
PL952 PL962	TX STATUS	TUNE	FILTER	TRIPLER	OSC

INTERCONNECTION DIAGRAM CQF9XXX
TRANSMITTER WITH SYNTHESIZER

D 403.903/2

ITEM NUMBER	DESCRIPTION
L855622G1	CABINET ASM RX
L855623G1	CABINET ASM TX
J708758G1	CABLE ASM, TX-:J10 TO INT.FACE
J708759G1	CABLE ASM, TX-:J9 TO INTERFACE
J708760G1	CABLE ASM, RX:J14 TO PA963-:J4
J708761G1	CABLE ASM, TX-:J7 TO PA963-:J3
J708762G1	CABLE ASM, RX-:J12 TO INT.FACE
J708763G1	CABLE ASM, RX-:J13 TO INT.FACE
J708880G1	CABLE ASM, GRND BTWN CABINETS
K805579G1	CABLE ASM, RF-COAX- F.RX 9XXX
K805618G3	CABLE ASM, COAX- W.PLUG UG88
K805618G4	CABLE ASM, COAX- W.PLUG UG88
K805632G1	CABLE ASM, POWER- 2-CONDUCT.
L855348G2	CABLE ASM
L855348G3	CABLE ASM, FREQ-FG-FS
J708915G1	KIT, RADIO ASM.-
J708884G1	MOUNTING PLATE ASM
L855741G1	WIRING ASM., INT.CONN. CABLE-

=====

P A R T S L I S T S :

ASM. DRWNG POSITION	COMPONENT ITEM NUMBER	COMPONENT DESCRIPTION	QUANTITY TOTAL
01 :	L855622G1 :	CABINET ASM, RX- :	
0002	L855625G1	BOTTOM ASM RX	1
0003	L855606G1	FRAME ASM RX	1
0004	J708818P6	RIV TUBR D-3.2X7.9	11
02 :	L855623G1 :	CABINET ASM, TX- :	
0002	L855626G1	BOTTOM ASM TX	1
0003	L855605G1	FRAME ASM. TX	1
0004	J708818P6	RIV TUBR D-3.2X7.9	12
0005	K805532P1	PLATE	1
03 :	J708758G1 :	CABLE ASM, TX-:J10 TO INT.FACE :	
0002	J708672P109	CABLE RIBBON 9 COND	0,330 M
0003	J708069P109	CONNECTOR SOCKET IDC	2
04 :	J708759G1 :	CABLE ASM, TX-:J9 TO INTERFACE :	
0002	J708672P110	CABLE RIBBON 10 COND	0,365 M
0003	J708069P110	CONNECTOR SOCKET IDC	2

ASM. DRWNG POSITION	COMPONENT ITEM NUMBER	COMPONENT DESCRIPTION	QUANTITY TOTAL
05 :	J708760G1 :	CABLE ASM, RX-:J14 TO PA963-:J4 :	
0002	J708672P104	CABLE RIBBON 4 COND	0,365 M
0003	J708069P104	CONN 4 POS	2
06 :	J708761G1 :	CABLE ASM, TX-:J7 TO PA963-:J3 :	
0002	J708672P103	CABLE RIBBON 3 COND	0,075 M
0003	J708069P103	CONN 3 POS	2
07 :	J708762G1 :	CABLE ASM, RX-:J12 TO INT.FACE :	
0002	J708672P110	CABLE RIBBON 10 COND	0,210 M
0003	J708069P110	CONNECTOR SOCKET IDC	2
08 :	J708763G1 :	CABLE ASM, RX-:J13 TO INT.FACE :	
0002	J708672P109	CABLE RIBBON 9 COND	0,265 M
0003	J708069P109	CONNECTOR SOCKET IDC	2
09 :	J708880G1 :	CABLE ASM, GRND. BTWN CABINETS :	
0002	J708834P1	TERMINAL	2
0003	J708835P1	CABLE	0,045 M
10 :	K805579G1 :	CABLE ASM, RF-COAX- F. RX 9XXX :	
0002	J706049P4	CABLE RF COAX	0,300 M
0003	J708634P1	TERMINAL D-3.2,L9	1
0004	A700171P1	CONN MALE PHONO	1
11 :	K805618G3 :	CABLE ASM, COAX- W. PLUG UG88 :	
0002	J706049P3	CABLE RF COAX 50R WRP PTF	0,517 M
0003	J707750P1	CONN COAX BNC PLUG UG 88	1
12 :	K805618G4 :	CABLE ASM, COAX- W. PLUG UG88 :	
0002	J706049P3	CABLE RF COAX 50R WRP PTF	0,122 M
0003	J707750P1	CONN COAX BNC PLUG UG 88	1

15/07/'85

STORNO - DEPT. OF SERVICE CO-ORDINATION

X404.137

JEV

ASM. DRWNG POSITION	COMPONENT ITEM NUMBER	COMPONENT DESCRIPTION	QUANTITY TOTAL
13 :	K805632G1 :	CABLE ASM, POWER- , 2-CONDUCT. :	
0002	J706180P1	CABLE POWER 2-COND BLACK	0,620 M
0003	J706684P5	TERM SPADE RECP 6.3MM	4
0004	J706964P1	CONN CONTACT AMP 180409-2	2
14 :	L855348G2 :	CABLE ASM, :	
P001	J706418P112	CONN PWB FEM 12 CKT	1
P003	A700041P29	CONN PWB FEM 03 CKT	1
X001	J707787P1	CONN PWB FEM RECP CLIP	3
0002	J707094P111	COVER	1
0003	J707210P1	WIRE 0.220 SQ., 'BROWN'	0,170 M
0004	J707210P2	WIRE 0.220 SQ., 'RED'	0,170 M
0005	J707210P3	WIRE 0.220 SQ., 'ORANGE'	0,170 M
0006	A700136P4	SLVG INS EL D-3.2X0.51 MM	0,145 M
15 :	L855348G3 :	CABLE ASM, FREQ-FG-FS :	
P001	J706418P112	CONN PWB FEM 12 CKT	1
P002	A700041P31	CONN PWB FEM 05 CKT	1
X001	J707787P1	CONN PWB FEM RECP CLIP	5
0002	J707094P111	COVER	1
0003	J707210P1	WIRE 0.220 SQ., 'BROWN'	0,125 M
0004	J707210P2	WIRE 0.220 SQ., 'RED'	0,125 M
0005	J707210P3	WIRE 0.220 SQ., 'ORANGE'	0,125 M
0006	J707210P4	WIRE 0.220 SQ., 'YELLOW'	0,125 M
0007	J707210P5	WIRE 0.220 SQ., 'GREEN'	0,125 M
0008	A700136P5	SLVG INS EL D-4.7X0.51 MM	0,100 M
16 :	J708915G1 :	KIT, RADIO ASM.- :	
0002	A701240P408	SCREW SOC HD M-4.0 X 8.0 MM	24
0003	A700031P310	SCREW PAN HD M-2.5 X 10.0 MM	2
0004	J708004P1	NAME PLATE ('STORNO')	1
0005	J708711P1	COVER	3
0006	J708942P1	HOLDER, CABLE-	4
0007	J708710P1	GASKET	1
0008	J708819P1	SCREEN CODE FINISH	1
0010	A701240P530	SCREW SOC HD M-5.0 X 30.0 MM	4
0011	J708836P1	WASHER	4

CONTINUED ON LAST PAGE: PAGE NO. 4.

ASM. DRWNG POSITION	COMPONENT ITEM NUMBER	COMPONENT DESCRIPTION	QUANTITY TOTAL
17 :	J708884G1 :	MOUNTING PLATE ASM. :	
0002	J709070P1	MOUNTING PLATE FINISH	1
0003	J709071P1	LOCK PLATE FINISH	1
0004	A701240P516	SCREW SOC HD M-5.0X16.0 MM	1
0005	A701312P7	WASH FLAT D-5.0X10.0 MM	1
0006	J709176P457	SCR RD HD WOOD D-5.0X30.0 MM	9
18 :	L855741G1 :	CABLE ASM., INT.CONN. CABLE-	
W001	J707210P1	WIRE 0.220 SQ., 'BROWN'	0,950 M
W002	J707210P2	WIRE 0.220 SQ., 'RED'	0,950 M
W003	J707210P3	WIRE 0.220 SQ., 'ORANGE'	0,950 M
W004	J707210P4	WIRE 0.220 SQ., 'YELLOW'	0,950 M
W005	J707210P5	WIRE 0.220 SQ., 'GREEN'	0,940 M
W006	J707210P6	WIRE 0.220 SQ., 'BLUE'	0,950 M
W007	J707210P7	WIRE 0.220 SQ., 'VIOLET'	0,950 M
W008	J707210P8	WIRE 0.220 SQ., 'GREY'	0,940 M
W009	J707210P9	WIRE 0.220 SQ., 'WHITE'	0,950 M
W010	J707210P20	WIRE 0.220 SQ., 'RED/BLACK'	0,950 M
W011	J707210P22	WIRE 0.220 SQ., 'PINK'	0,950 M
W012	J707210P26	WIRE 0.220 SQ., 'RED/BLUE'	0,950 M
W013	J707210P35	WIRE 0.220 SQ., 'OR/GREEN'	0,950 M
W014	J707210P40	WIRE 0.220 SQ., 'YELL/BLACK'	0,950 M
W015	J707210P45	WIRE 0.220 SQ., 'YELL/GREEN'	0,950 M
W016	J707210P46	WIRE 0.220 SQ., 'YELL/BLUE'	0,950 M
W017	J707210P50	WIRE 0.220 SQ., 'GREEN/BLACK'	0,940 M
W018	J707210P52	WIRE 0.220 SQ., 'GREEN/RED'	0,950 M
W019	J707210P58	WIRE 0.220 SQ., 'GREY/GREEN'	0,940 M
W020	J707210P82	WIRE 0.220 SQ., 'GREY/RED'	0,950 M
W021	J707210P89	WIRE 0.220 SQ., 'GREY/WHITE'	0,950 M
W022	J707210P90	WIRE 0.220 SQ., 'WHITE/BLACK'	0,950 M
W023	J707210P91	WIRE 0.220 SQ., 'WHITE/BROWN'	0,950 M
W024	J707210P92	WIRE 0.220 SQ., 'WHITE/RED'	0,950 M
W025	J707210P94	WIRE 0.220 SQ., 'WHITE/YELLOW'	0,950 M
W026	J707210P95	WIRE 0.220 SQ., 'WHITE/GREEN'	0,950 M
W027	J707210P96	WIRE 0.220 SQ., 'WHITE/BLUE'	0,950 M
W028	J707210P100	WIRE 0.220 SQ., 'BLACK'	0,950 M
W029	J707210P100	WIRE 0.220 SQ., 'BLACK'	0,950 M
W030	J707210P100	WIRE 0.220 SQ., 'BLACK'	0,950 M
W031	J707210P100	WIRE 0.220 SQ., 'BLACK'	0,950 M
W032	J707210P100	WIRE 0.220 SQ., 'BLACK'	0,180 M
0002	J708069P109	CONNECTOR SOCKET IDC	1
0003	J708069P114	CONN 14 PIN	1
0004	J708069P103	CONN 3 POS	1
0005	J708069P103	CONN 3 POS	1
0006	A700136P5	SLVG INS EL D-4.7X0.51 MM	0,050 M
0007	J706566P17	CONN MALE 34 CKT	1

CHAPTER
CHAPITRE
KAPITEL

4

Storno

INSTALLATION

INSTALLATION OF THE CABINET

GENERAL

The site for a fixed radio station should be chosen on a basis of the following factors:

- The distance between the station and the antenna should be as short as possible so as to limit the length of the antenna feed cable and hence also the losses involved.
- Maximum ambient temperature permitted for the equipment is 60°C, and the temperature in the station room should never exceed this limit. Since all the heat generated in the equipment must be drained away through the surface of the cabinet, it is important to avoid covering up the latter.
- In order to secure easy access to all circuits in the event of service, sufficient room should be left around the cabinet so that it can be opened, thereby making the circuitry accessible.

INSTALLATION OF THE CABINET

The Stornophone 9000 fixed radio station is intended for wall mounting. STORNO can supply the following types of suspension:

T-suspension (code No. J708884G1). For use where the equipment may be exposed to vibrations, making particularly rugged mounting a necessity. In order to remove the cabinet from the suspension it is necessary to loosen a locking screw, using an Unbrako key (L-shaped hexagonal key).

T-suspension (code No. J708884G2). Identical with the T-suspension described above except that the locking screw is spring activated and can be loosened without using tools.

T-SUSPENSION (CODE NO. J708884G1 OR G2)

A T-suspension is a kit comprising the following parts:

- One suspension plate with locking pawl.
- Nine wood screws.

The mechanical drawing M905.193 shows how to mount the cabinet. All dimensions are listed.

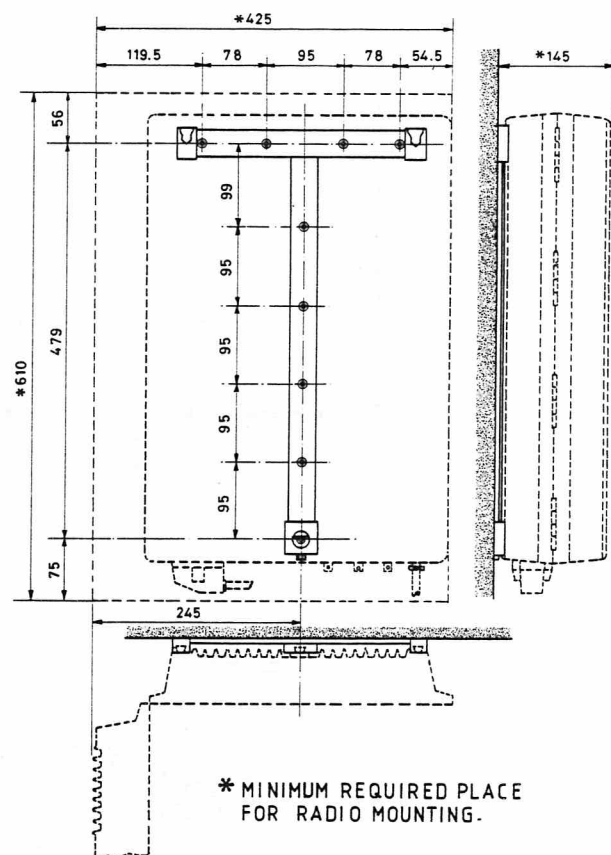

(all dimensions are in millimeters)

MOUNTING BRACKET FOR CQF9000
CODE No. J708884G1

M405.193/2

INSTALLATION OF CABLING

The cabling required for operation of the Storno-
phone 9000 fixed radio station comprises:

- Power cable
- Antenna cable
- Control cable

Power Cable

Bring the power cable from the mains or accumu-
lator through the hole in the bottom of the cabinet
and connect it to the power supply unit of the e-
quipment.

Antenna Cable

Plug the antenna cable, with a connector mounted
on it, into the station's antenna connector (UHF
connector, Type N).

Control Cable

The control cable connects the control equipment to
the multiconnector of the radio station.

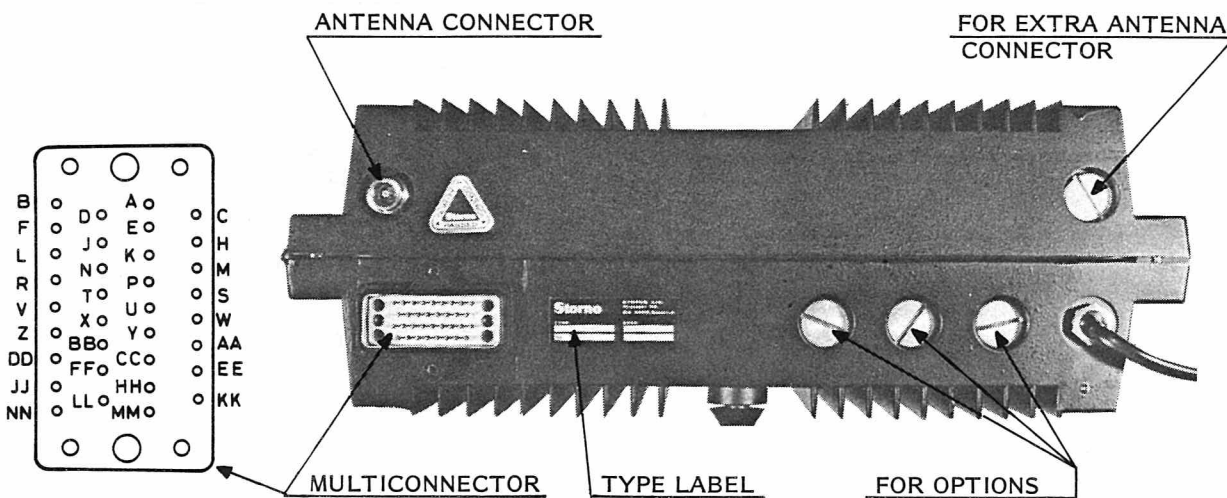
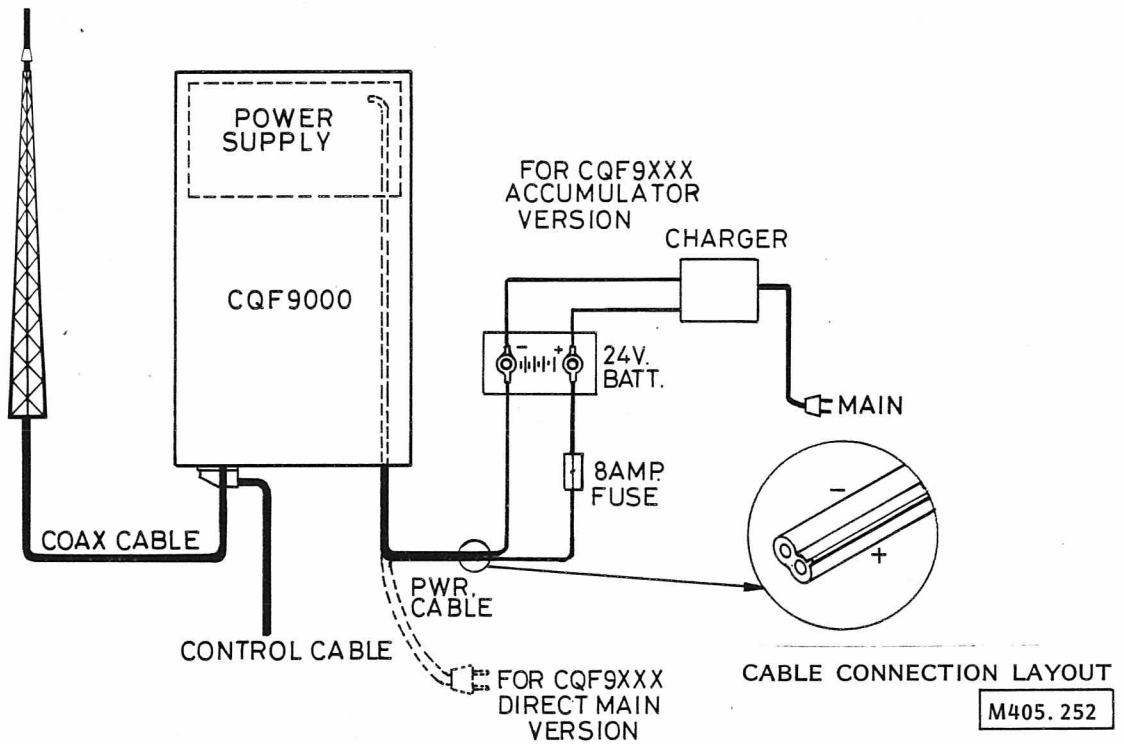

MULTICONNECTOR TERMINALS

Terminal	Colour	Function	Terminal	Colour	Function
B	green/brown	TX MOD IN	A	grey	RX AF OUT
F	green	TX MOD IN	E	grey/green	RX AF OUT
L	black	GND	K	black	GND
R	blue	-24 V TX	P	violet	-24 V RX
V	yellow	TX KEY	U	black/red	SQ CANCELLING
Z	grey/red	GROUP	Y	blue/yellow	-24 V CONT.
DD	black	GND	CC	black	GND
JJ	pink	GND	HH	white/yellow	START
NN	orange	OUT C"	MM	red	START LAMP
D	white/brown	CH1 + CH9	C	blue/red	RSSI
J	white/red	CH2 + CH10	H	orange/green	SPARE
N	red/green	CH3 + CH11	M	green/blue	SPARE
T	white/green	CH4 + CH12	S	brown	SQ OUT
X	white/blue	CH5	W	NC	
BB	white/grey	CH6	AA	yellow/black	CH. GUARD
FF	white/black	CH7	EE	NC	
LL	white	CH8	KK	NC	

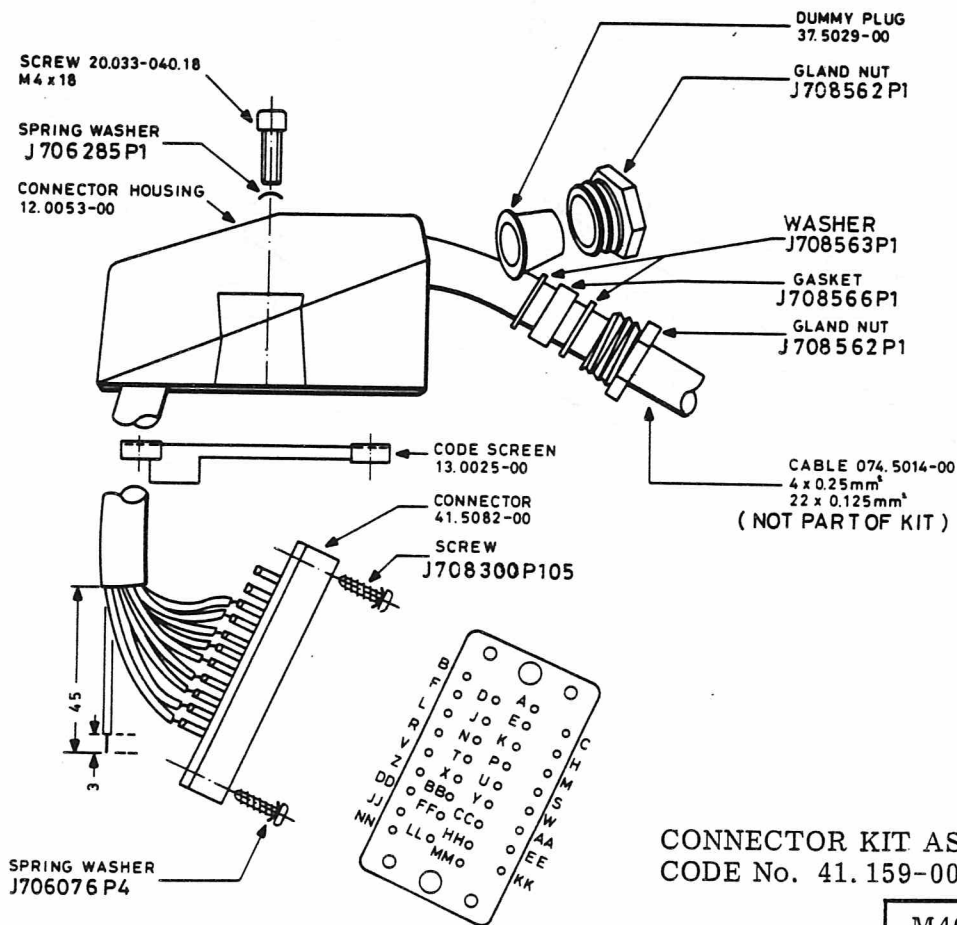

ANTENNA INSTALLATION

FULLY ISOLATED 50 ohm RF-COAXIAL CABLE

Cable type	Diameter in mm						Attenuat. Curve	Weight kg/100 m	
	D ₁	D ₂	D ₃	D ₄	D ₅	D ₆			
RG-213/U (2,1 L 7,3)	2,3	7,3	8,2	10,3	-	-	2	15,9	

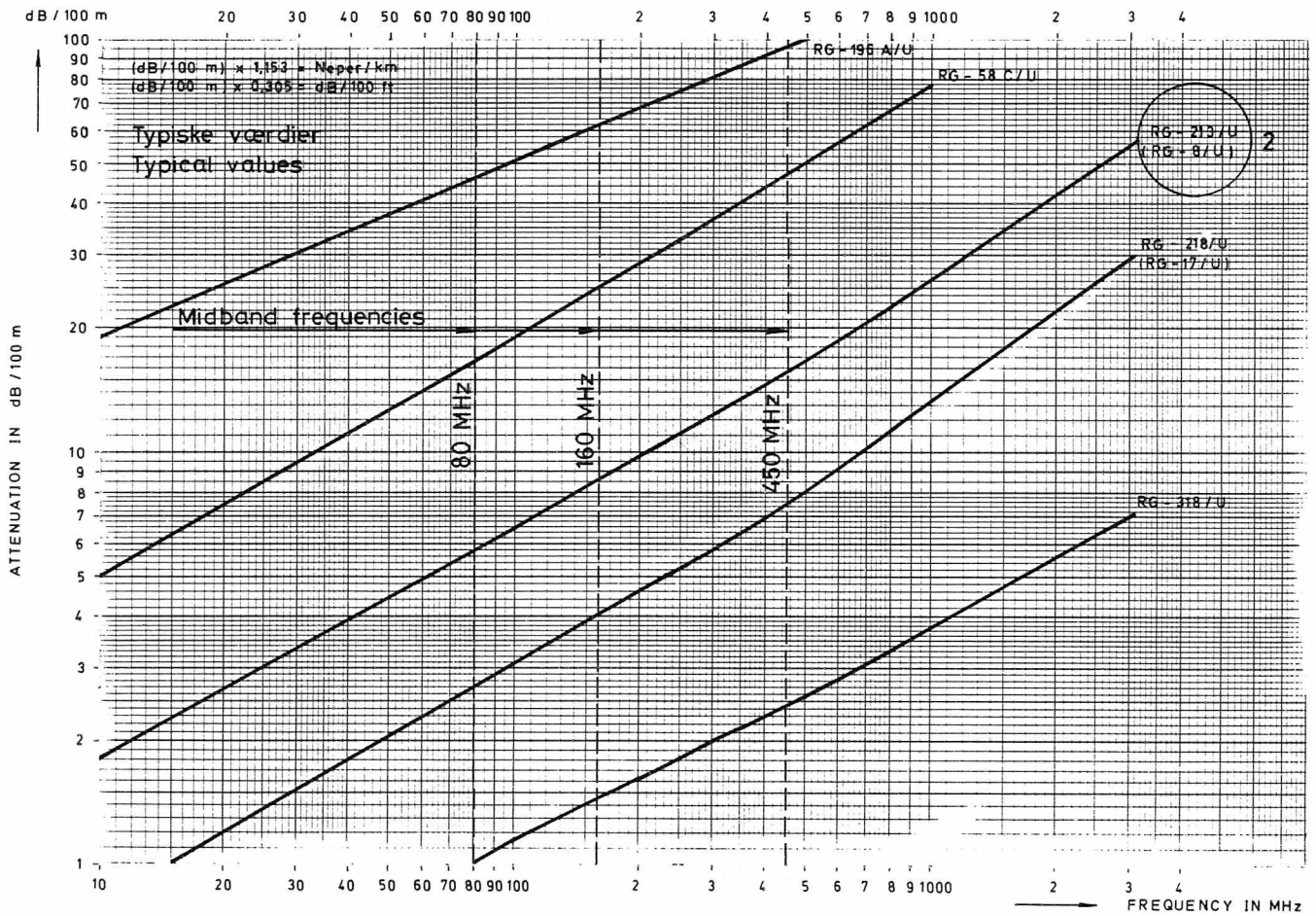

NOTE: In standard installations, the loss due to cable attenuation must not exceed 3 dB.

CAUTION: To avoid maintenance problems it is recommended to use about 1.5 m of the above cable between the base station antenna connector and the fixed cable installation.

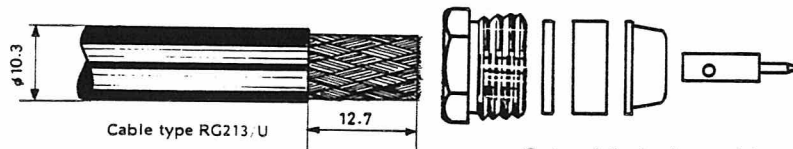

1

Cut cable jacket without damaging the braid wires.

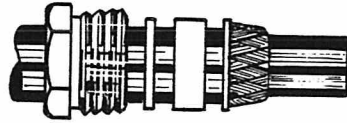

2

Insert clamp nut, washers, gasket and braid clamp over cable, fan out braid clamp and trim to length.

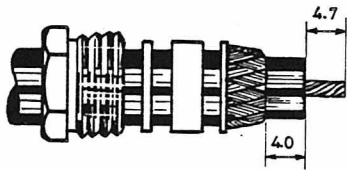

3

Cut cable dielectric and tin exposed conductor with coating of solder.

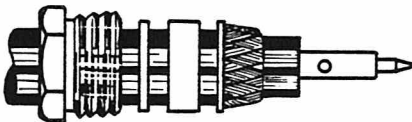

4

Solder the contact to the conductor by sweating together applying minimum heat or fill up solder through the hole. Cool the soldering point in sprit, remove superfluous solder and clean the contact.

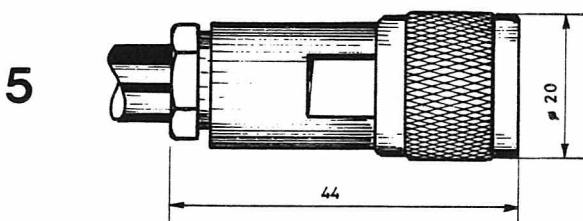

5

Insert assembly into connector body and tighten moderately.

CABLE MOUNTING INSTRUCTION FOR CABLE
TYPE RG213/U & N-CONNECTOR UG21B/U
CODE No. 41.5115

M405.240

CHAPTER
CHAPITRE
KAPITEL

5

Storno

IU903

INTERFACE UNIT

The IU903 interface unit provides all functions for connecting a CQF9000 base station to a CAF600 control equipment.

Three versions of the interface unit are available:

- K805621G1 Interface for 1 channel multiplier station.
- K805621G2 Interface for multiplier station with more than 1 channel.
- K805621G3 Interface for synthesizer station with up to 12 channels.

The interface is mounted in the radio station and connects to the receiver and transmitter boxes by means of a set of flat cables.

A cable loom which terminates in a multiconnector connects to the control equipment.

The interface comprises the following functions:

- Power on/off circuit
- TX key circuit
- 12 V to 24 V DC/DC converter
- 24 V continuous voltage regulator
- 24 V RX
- 24 V TX
- Squelch cancel circuit
- Squelch signal circuit
- Channel control circuit (12 channels)
- Power supply-board (5 V, 9 V)

RECEIVER INTERFACE TO CONTROL EQUIPMENT

The interface unit provides the following receiver functions and signals for the control equipment:

- Non-deemphased AF output, assymetrical.
- Gate control of RX audio signal
- Squelch signal
- Channel control, oscillator enable/RX synthesizer 10.8 - 15.6 V DC
- Radio Signal Strength Indication (RSSI)
- Chassis

The deemphased AF output from the receiver is at line level and applied directly to the control equipment multiconnector.

TRANSMITTER INTERFACE TO CONTROL EQUIPMENT

The interface unit provides the following transmitter functions and signals for the control equipment:

- Channel guard subaudio input, assymetrical
- Transmitter Key circuit
- RF output power indication
- Channel control, oscillator enable/TX synthesizer 10.8 - 15.6 V DC
- Chassis

The AF modulation signal is applied directly to the transmitter from the control equipment multiconnector.

CIRCUIT DESCRIPTION

CONTROL EQUIPMENT INTERFACE

The interface unit comprises a DC-DC converter and -24 V power supply, logic and voltage level circuitry for converting the control equipment signals to the CQF9000 levels and polarities.

DC-DC CONVERTER

The -24 V DC for the control equipment is generated by a DC-DC converter which operates from +12 V DC. The converter is a push-pull configuration operating at approximately 12 kHz. The rectified output is stabilised and the output current capacity is 0.5 A. The output voltage is adjustable by means of potentiometer R75. The circuitry includes an enable gate formed by Q32-Q33, and a filter to suppress converter noise.

5 V REGULATOR

A 5 V regulator for the synthesizer control circuit is formed by Q34, R91 and D18 and can be gated on and off by Q35.

9 V SUPPLY

The +9 V required by the TX KEY and the SQ. CANCEL circuitry is derived from the receiver and transmitter. The diodes D4 and D5 isolates the two inputs.

START (ON/OFF)

The START function is enabled from the control equipment by grounding the start input (J17/10). This turns Q35 on which enables the -24 V DC converter via D16, the 5 V regulator via D17, the RX VR GATE via D3 and the TX VR GATE via D2. When the DC converter is enabled +12 V is available at J17/9 via a series resistor for a start lamp.

TRANSMITTER KEY

The control equipment signals transmitter key by pulling the key line to chassis. The interface circuit converts this to CQF9000 level which means that the line is being pulled to +9 V.

When the TX KEY is pulled to chassis opto-coupler U3 turns Q18 and Q20 off.

A 5 ms delay (R59-C15) is inserted between Q18 and the relay transistor Q19 to ensure that the transmitter is not enabled before the antenna switch relay is activated.

Transistor Q20 drives Q21 on and this activates the antenna relay. D6 is a protection diode parallel to the antenna relay coil.

The TX KEY signal is also applied to the -24 V RX/TX switching circuit Q22, Q23, Q24.

In simplex stations the -24 V RX is switched off during transmit and -24 V TX on during transmit.

In duplex stations strap W1 is omitted and hence the -24 V RX is not switched off during transmit.

SQUELCH SIGNAL AND AUDIO GATE

The control equipment requires the following squelch signals:

- 20 V: No carrier - Squelch path blocked
- 11 V: Carrier present

The squelch interface converts the receiver squelch signals to comply with these levels.

The squelch interface consists of Q25, R70, R71 and R27. When the base of Q25 is pulled low, either by the receiver squelch (SQ OUT) or by keying the transmitter, the squelch voltage to the control equipment changes from -11 V to -20 V.

The receiver audio gate (CONTROL A) is controlled by the TX KEY which disables the receiver audio signal during transmit. In duplex stations strap W1 is omitted and hence the activation of the TX KEY will not activate the receiver audio gate.

SQUELCH CANCEL

The squelch adjustment potentiometer in the control equipment must be disconnected and the squelch level adjusted as described in the adjustment procedure. Provisions have been made for cancelling the squelch function from the control equipment by pulling SQ. CANCELLING (J17/8) to chassis. This turns Q17 on via optocoupler U3 and hence puts +9 V on the receiver's SQ. CANCEL input.

CHANNEL CONTROL

The interface unit has provisions for controlling up to 12 channels. The control equipment has 8 channel lines and 1 group switch line. When a channel is selected the corresponding line is pulled to chassis and for channel 9 to 12 the GROUP line is pulled to chassis too.

- Channel 1: CH1 - J16/9 to chassis
- Channel 2: CH2 - J16/8 to chassis
- Channel 3: CH3 - J16/7 to chassis
- Channel 4: CH4 - J16/6 to chassis
- Channel 5: CH5 - J16/5 to chassis
- Channel 6: CH6 - J16/4 to chassis
- Channel 7: CH7 - J16/3 to chassis
- Channel 8: CH8 - J16/2 to chassis
- Channel 9: CH1+GROUP - J16/9+J16/1 to chassis
- Channel 10: CH2+GROUP - J16/8+J16/1 to chassis
- Channel 11: CH3+GROUP - J16/7+J16/1 to chassis
- Channel 12: CH4+GROUP - J16/6+J16/1 to chassis

SYNTEHSIZER CHANNEL SELECT

The channel select function is via optocoupler U3 applied to an inverter whose output is being converted to a binary code in U6. The binary code is used to address the RX and TX proms that contain the channel data. The prom output is buffered and inverted before being presented to the synthesizer.

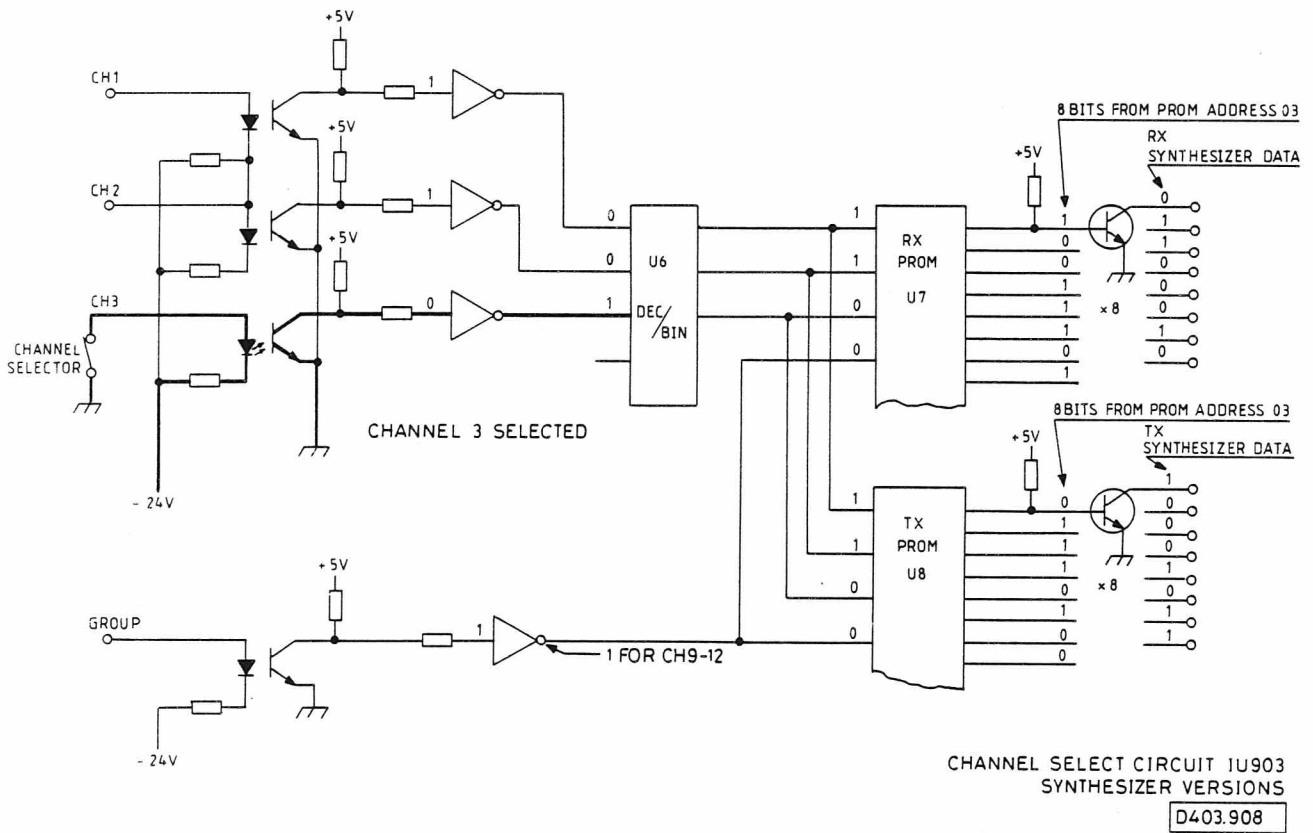

MULTIPLIER CHANNEL SELECT

The channel select function is, via the optocoupler, an inverter and a buffer transistor, used to select the channel oscillators in the receiver and transmitter.

DIRECT LINES

The following radio functions are going directly through the interface unit:

- RSSI Radio Signal strength indication
- C OUTPUT Non deemphased RX audio output
- CH. GUARD Subaudio input for TX channel guard
- SPARE 1+2 Two spare lines
- CHASSIS Chassis return for all functions

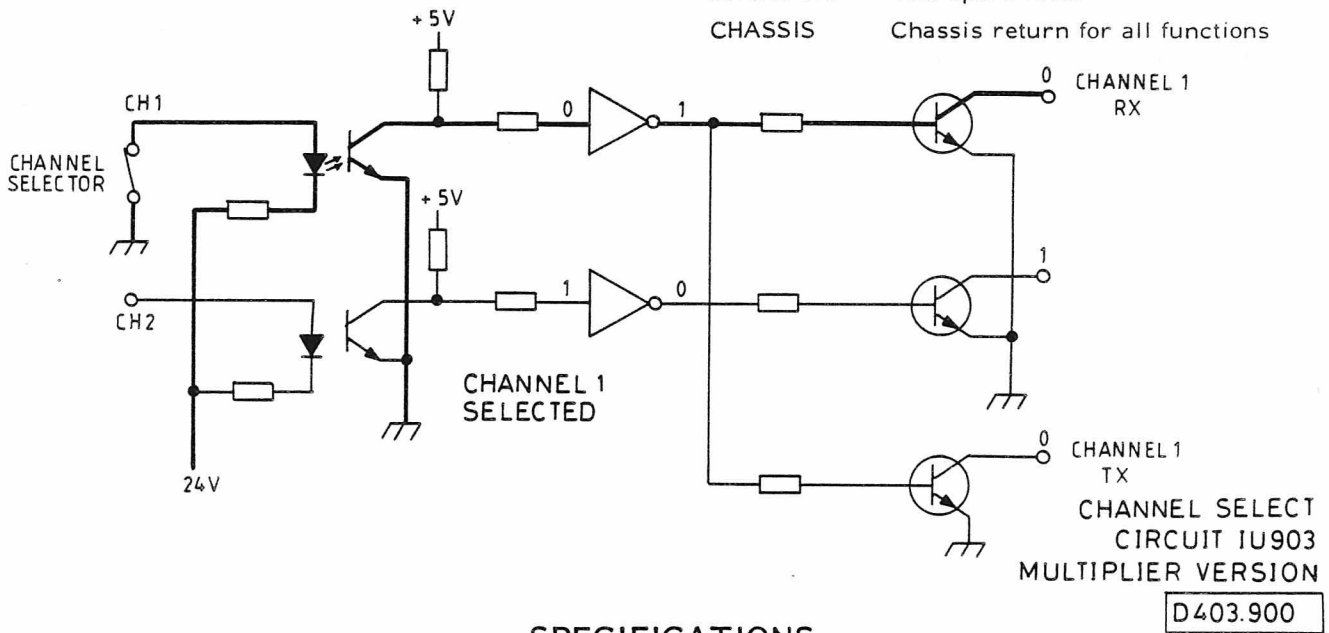

SPECIFICATIONS

DC-DC CONVERTER

Input Voltage

- +12 V nominal
- +10.8 V minimum
- +15.6 V maximum

Converter Frequency

12 kHz

Current Drain

- max. 0.5 A without load
- max. 2.0 A with 0.5 A load

Output Voltage

-24 V ±1.2 V

5 V REGULATOR

Input Voltage

10.8 - 15.6 V

Output Voltage

5 V ±0.5 V

9 V SUPPLY

Input Voltage

9 V ±0.5 V

SQUELCH

Squelch signal levels

- Squelched: -20 V ±10%
- Unsquelched: -11 V ±10%

TEMPERATURE RANGE

-25°C to +70°C

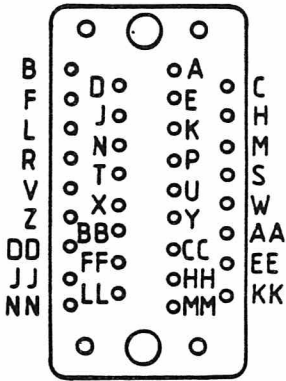

CONTROL CONNECTOR

IU903

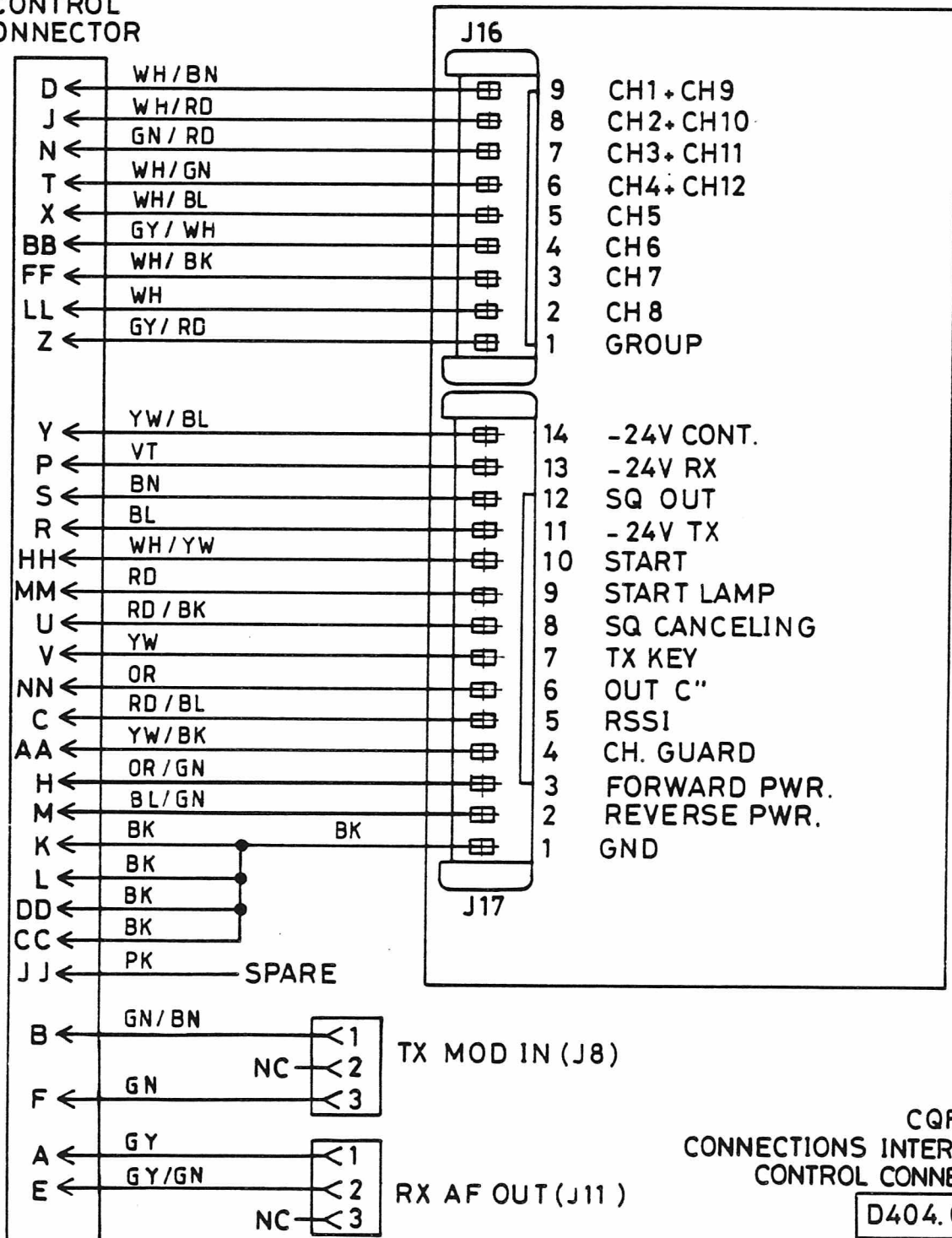

CQF 9000
CONNECTIONS INTERFACE/
CONTROL CONNECTOR

D404.013/3

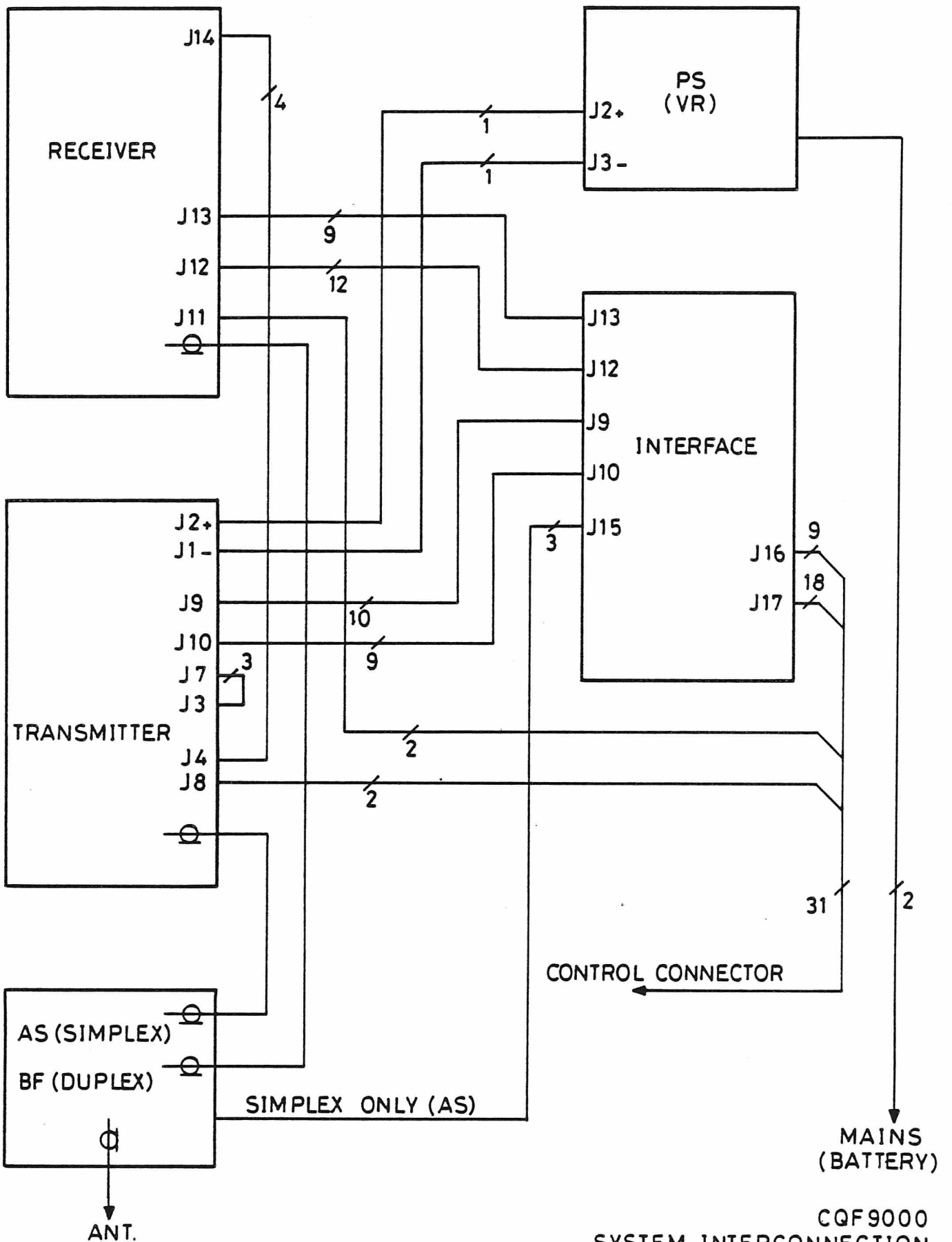

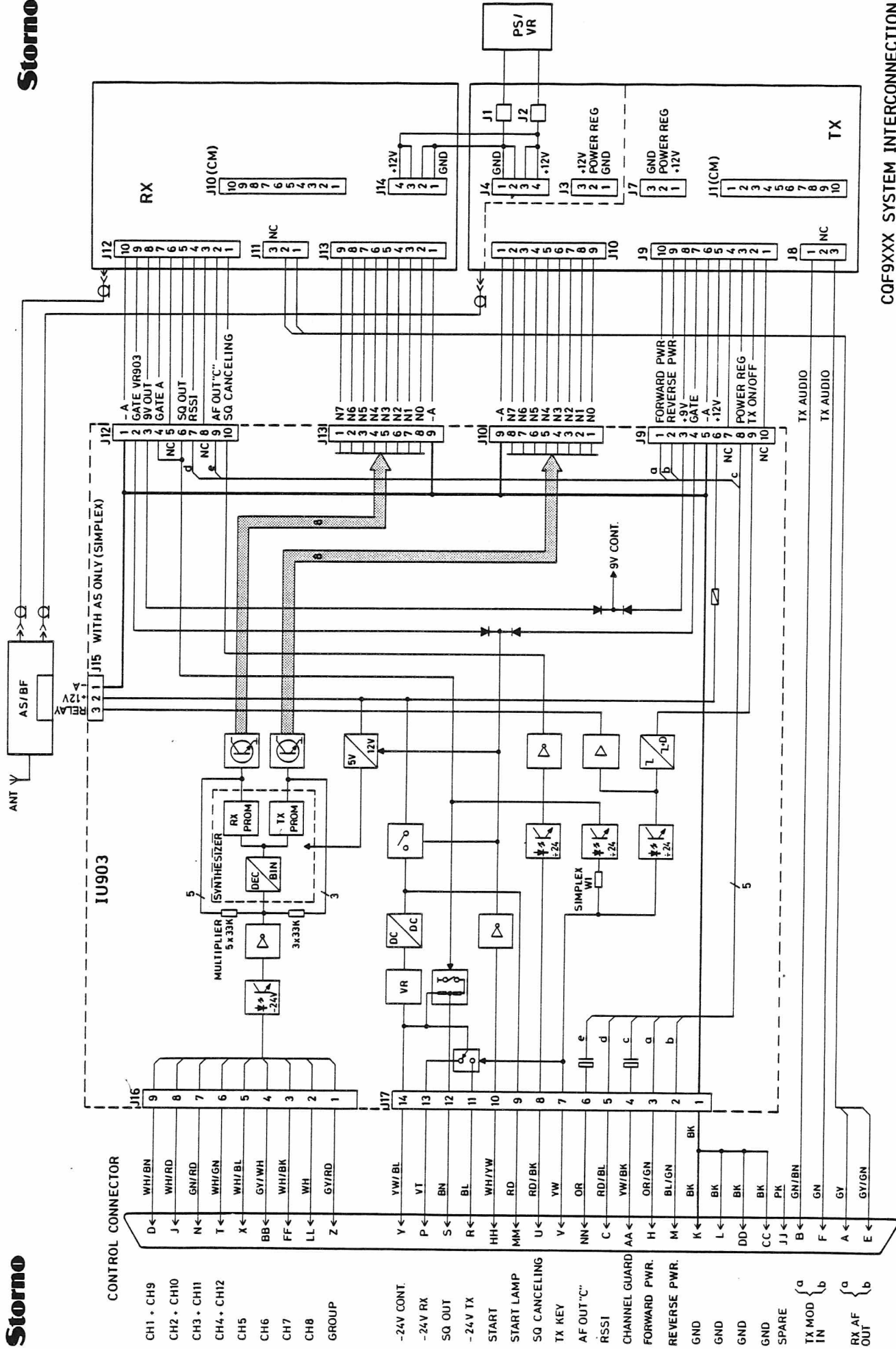

CQF9XXX SYSTEM INTERCONNECTION
FUNCTIONAL DIAGRAM D404.18712

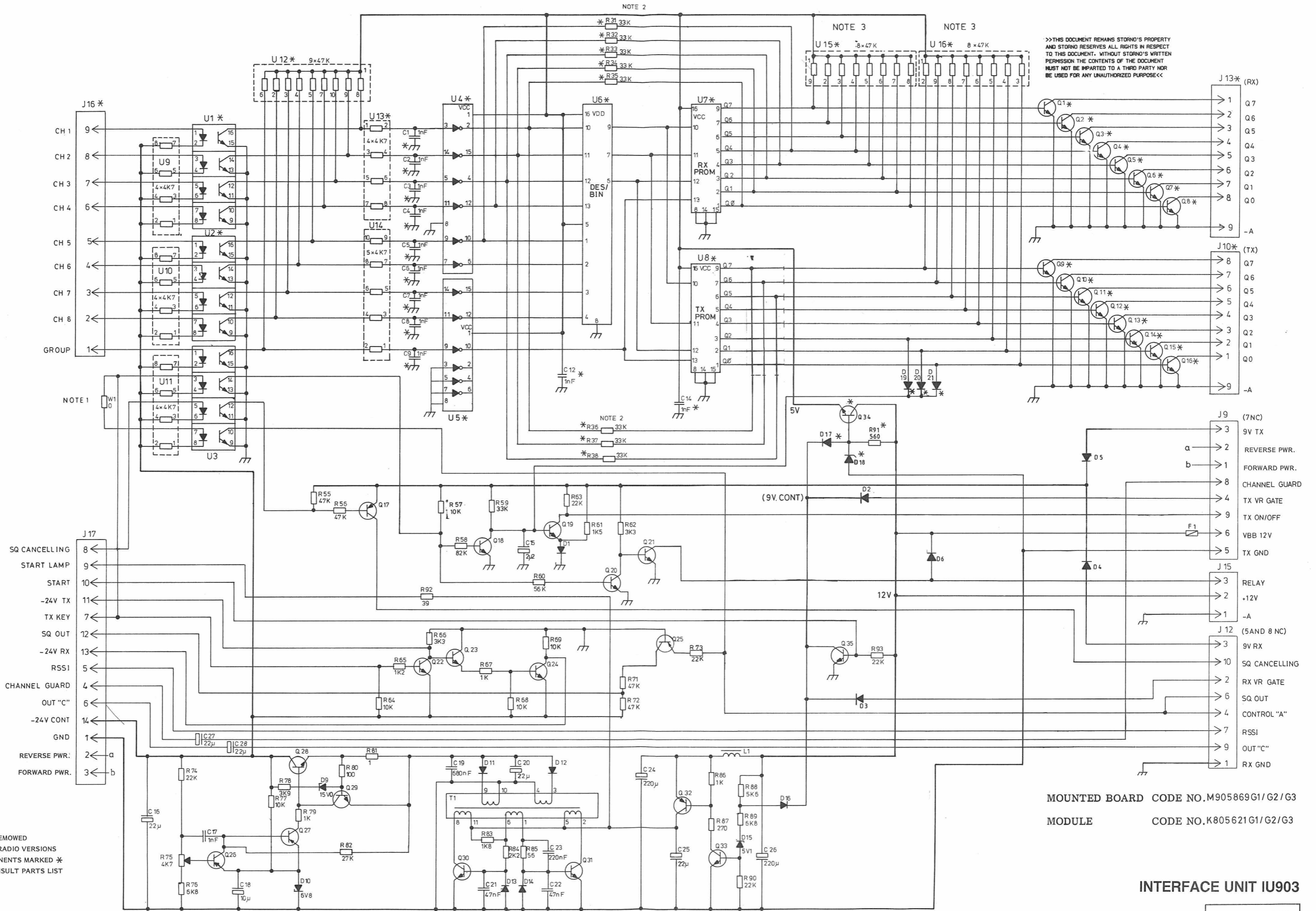

>>>THIS DOCUMENT REMAINS STORNO'S PROPERTY AND STORNO RESERVES ALL RIGHTS IN RESPECT TO THIS DOCUMENT. WITHOUT STORNO'S WRITTEN PERMISSION THE CONTENTS OF THE DOCUMENT MUST NOT BE IMPARTED TO A THIRD PARTY NOR BE USED FOR ANY UNAUTHORIZED PURPOSE<<<

NOTES:
 1. W1 TO BE REMOVED IN DUPLEX RADIO VERSIONS
 2. FOR COMPONENTS MARKED * PLEASE CONSULT PARTS LIST FOR IU903

MOUNTED BOARD CODE NO. M905869G1/G2/G3
 MODULE CODE NO. K805621G1/G2/G3

INTERFACE UNIT IU903

REV.C D404.388/4

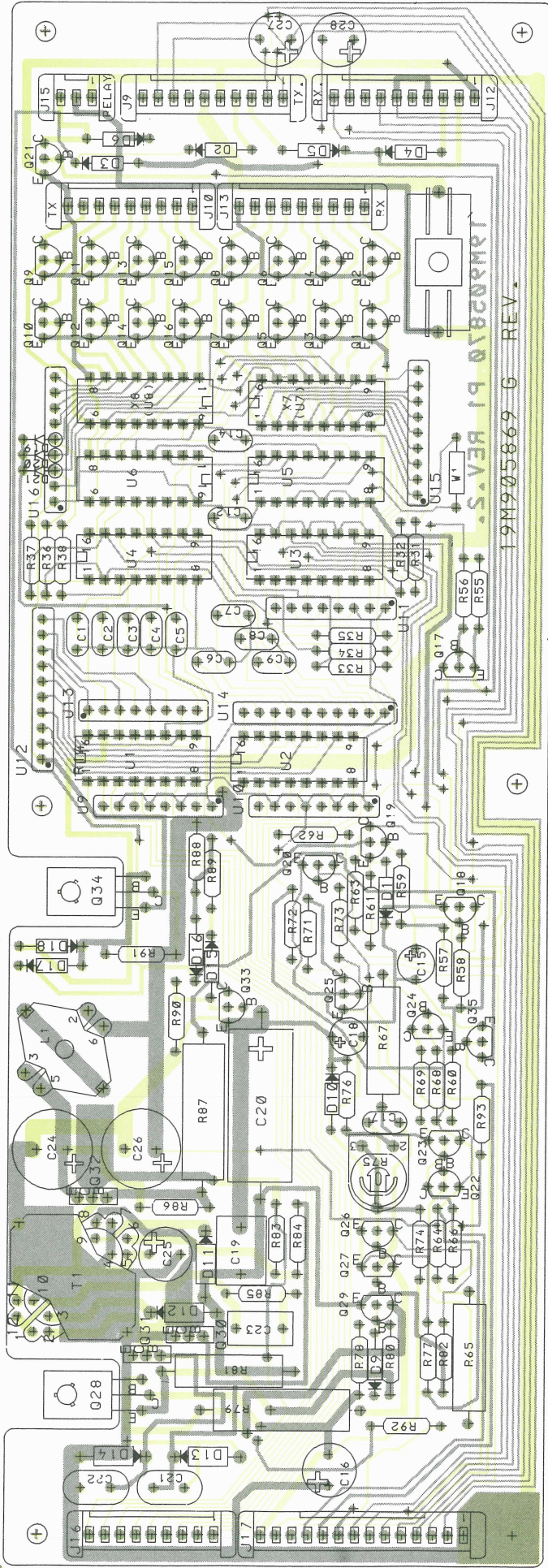

INTERFACE UNIT IU903
COMPONENT BOARD

REV. 2 D404. 389

MODULE CODE NO.	MOUNTED BOARD CODE NO.	VERSIONS
K805621G1	M905869G1	MULTIPLIER - 1 CHANNEL
" " G2	" " G2	MULTIPLIER - 5/3 OR 3/2 CHANNELS
" " G3	" " G3	SYNTHESIZER VERSION

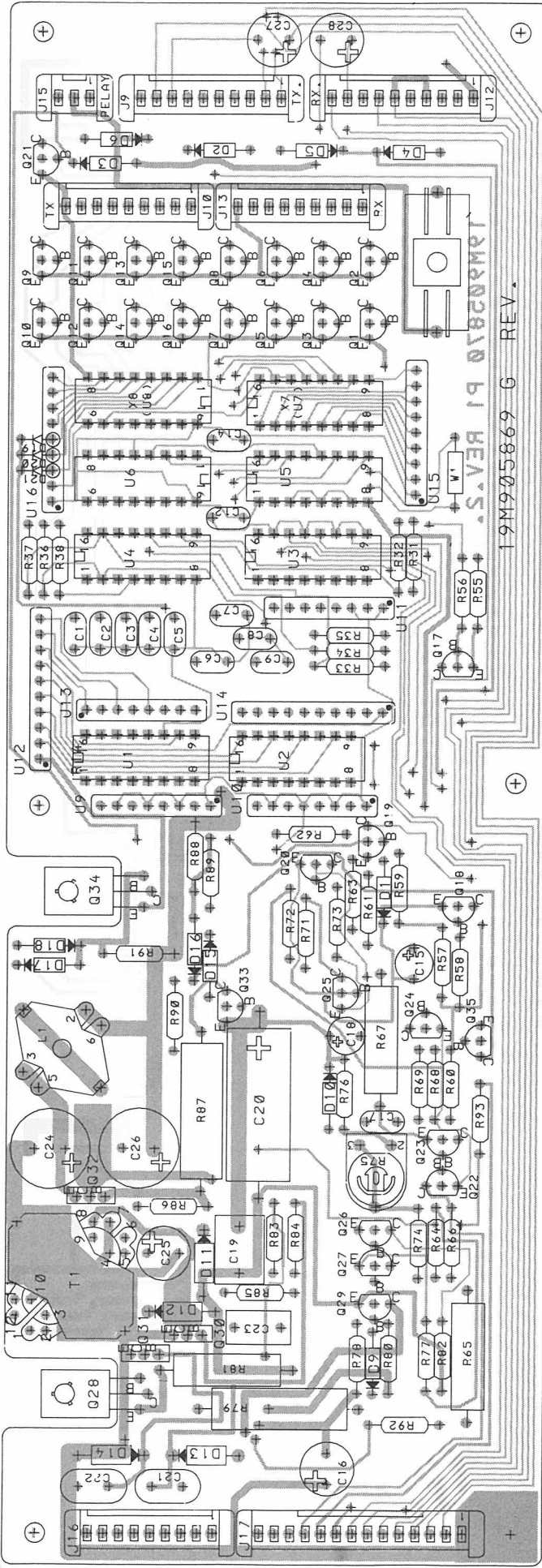

INTERFACE UNIT IU903
 COMPONENT BOARD

REV. 2 D404. 389

MODULE CODE NO.	MOUNTED BOARD CODE NO.	VERSIONS
K805621G1	M905869G1	MULTIPLIER - 1CHANNEL
" " G2	" " G2	MULTIPLIER - 5/3 OR 3/2 CHANNELS
" " G3	" " G3	SYNTHESIZER VERSION

DATE: 9/16/1987

Pos	Code No	Description	Qt
C001	A700234P1	CAP PYES 1N0 10%	1
C002	A700234P1	CAP PYES 1N0 10%	1
C003	A700234P1	CAP PYES 1N0 10%	1
C004	A700234P1	CAP PYES 1N0 10%	1
C005	A700234P1	CAP PYES 1N0 10%	1
C006	A700234P1	CAP PYES 1N0 10%	1
C007	A700234P1	CAP PYES 1N0 10%	1
C008	A700234P1	CAP PYES 1N0 10%	1
C009	A700234P1	CAP PYES 1N0 10%	1
C015	J707444P5	CAP TA SOL 2U2 35V	1
C016	J706005P2	CAP ELECT 22U 40V	1
C017	A700234P1	CAP PYES 1N0 10%	1
C018	A701534P7	CAP TA SOL 10U 16V	1
C019	A700004P7	CAP PYES 680N 10%	1
C020	J706354P2	CAP AL SOL 22U 40V	1
C021	A700234P11	CAP PYES 47N 10%	1
C022	A700234P11	CAP PYES 47N 10%	1
C023	A700004P4	CAP PYES 220N 10%	1
C024	J706005P5	CAP ELECT 220U 16V	1
C025	J706005P2	CAP ELECT 22U 40V	1
C026	J706005P5	CAP ELECT 220U 16V	1
C027	J706005P2	CAP ELECT 22U 40V	1
C028	J706005P2	CAP ELECT 22U 40V	1
D001	A700028P1	DIO SI SIG 1N4148	1
D002	A700028P1	DIO SI SIG 1N4148	1
D003	A700028P1	DIO SI SIG 1N4148	1
D004	A700028P1	DIO SI SIG 1N4148	1
D005	A700028P1	DIO SI SIG 1N4148	1
D006	A700028P1	DIO SI SIG 1N4148	1
D009	A700025P12	DIO SI ZENR 15V 5% 0.4W	1
D010	A700025P8	DIO SI ZENR 6V8 5% 0.4W	1
D011	J706282P1	DIO SI PWR 1N4933	1
D012	J706282P1	DIO SI PWR 1N4933	1
D013	J706282P1	DIO SI PWR 1N4933	1
D014	J706282P1	DIO SI PWR 1N4933	1
D015	A700025P6	DIO SI ZENR 5V1 5% 0.4W	1

Pos	Code No	Description	Qt
D016	A700028P1	DIO SI SIG 1N4148	1
D017	A700028P1	DIO SI SIG 1N4148	1
D018	A700025P7	DIO SI ZENR 5V6 5% 0.4W	1
D019	A700047P3	DIO SI SIG 1N6263	1
D020	A700047P3	DIO SI SIG 1N6263	1
D021	A700047P3	DIO SI SIG 1N6263	1
F001	J706998P8	FUSE CTG 3.15A T	1
J009	J708068P10	CONN PWB MALE RECP 10-CKT	1
J010	J708068P9	CONN PWB MALE RECP 09-CKT	1
J012	J708068P10	CONN PWB MALE RECP 10-CKT	1
J013	J708068P9	CONN PWB MALE RECP 09-CKT	1
J015	J708068P3	CONN PWB MALE RECP 03-CKT	1
J016	J708068P9	CONN PWB MALE RECP 09-CKT	1
J017	J708068P14	CONN PWB MALE RECP 14-CKT	1
L001	K805076G3	COIL ASM	1
Q001	J707511P1	TSTR NPN SI BC 548A/B	1
Q002	J707511P1	TSTR NPN SI BC 548A/B	1
Q003	J707511P1	TSTR NPN SI BC 548A/B	1
Q004	J707511P1	TSTR NPN SI BC 548A/B	1
Q005	J707511P1	TSTR NPN SI BC 548A/B	1
Q006	J707511P1	TSTR NPN SI BC 548A/B	1
Q007	J707511P1	TSTR NPN SI BC 548A/B	1
Q008	J707511P1	TSTR NPN SI BC 548A/B	1
Q009	J707511P1	TSTR NPN SI BC 548A/B	1
Q010	J707511P1	TSTR NPN SI BC 548A/B	1
Q011	J707511P1	TSTR NPN SI BC 548A/B	1
Q012	J707511P1	TSTR NPN SI BC 548A/B	1
Q013	J707511P1	TSTR NPN SI BC 548A/B	1
Q014	J707511P1	TSTR NPN SI BC 548A/B	1
Q015	J707511P1	TSTR NPN SI BC 548A/B	1
Q016	J707511P1	TSTR NPN SI BC 548A/B	1
Q017	J707674P1	TSTR PNP SI BC 558A/B	1
Q018	J707511P1	TSTR NPN SI BC 548A/B	1
Q019	J707511P1	TSTR NPN SI BC 548A/B	1
Q020	J707511P1	TSTR NPN SI BC 548A/B	1
Q021	J707511P1	TSTR NPN SI BC 548A/B	1

DATE: 9/16/1987

Pos	Code No	Description	Qt
Q022	J707267P2	TSTR NPN SI BC 338-25	1
Q023	J707511P1	TSTR NPN SI BC 548A/B	1
Q024	J707267P2	TSTR NPN SI BC 338-25	1
Q025	J707674P1	TSTR PNP SI BC 558A/B	1
Q026	J707674P1	TSTR PNP SI BC 558A/B	1
Q027	A700022P2	TSTR PNP SI 2N3906	1
Q028	J707594P1	TSTR NPN SI BD 437	1
Q029	J707511P1	TSTR NPN SI BC 548A/B	1
Q030	J707594P1	TSTR NPN SI BD 437	1
Q031	J707594P1	TSTR NPN SI BD 437	1
Q032	J708620P1	TSTR PNP SI BD 438	1
Q033	J707511P1	TSTR NPN SI BC 548A/B	1
Q034	J707594P1	TSTR NPN SI BD 437	1
Q035	J707511P1	TSTR NPN SI BC 548A/B	1
R031	A700019P55	RES DEPC 1/4W 33K	1
R032	A700019P55	RES DEPC 1/4W 33K	1
R033	A700019P55	RES DEPC 1/4W 33K	1
R034	A700019P55	RES DEPC 1/4W 33K	1
R035	A700019P55	RES DEPC 1/4W 33K	1
R036	A700019P55	RES DEPC 1/4W 33K	1
R037	A700019P55	RES DEPC 1/4W 33K	1
R038	A700019P55	RES DEPC 1/4W 33K	1
R055	A700019P57	RES DEPC 1/4W 47K	1
R056	A700019P57	RES DEPC 1/4W 47K	1
R057	A700019P49	RES DEPC 1/4W 10K	1
R058	A700019P60	RES DEPC 1/4W 82K	1
R059	A700019P55	RES DEPC 1/4W 33K	1
R060	A700019P58	RES DEPC 1/4W 56K	1
R061	A700019P39	RES DEPC 1/4W 1K5	1
R062	A700019P43	RES DEPC 1/4W 3K3	1
R063	A700019P53	RES DEPC 1/4W 22K	1
R064	A700019P49	RES DEPC 1/4W 10K	1
R065	J706056P38	RES DEPC 1/2W 1K2	1
R066	A700019P43	RES DEPC 1/4W 3K3	1
R067	J706056P37	RES DEPC 1/2W 1K0	1
R068	A700019P49	RES DEPC 1/4W 10K	1

Pos	Code No	Description	Qt
R069	A700019P49	RES DEPC 1/4W 10K	1
R071	A700019P57	RES DEPC 1/4W 47K	1
R072	A700019P57	RES DEPC 1/4W 47K	1
R073	A700019P53	RES DEPC 1/4W 22K	1
R074	A700019P53	RES DEPC 1/4W 22K	1
R075	J706008P8	RES VAR CERM 4K7	1
R076	A700019P47	RES DEPC 1/4W 6K8	1
R077	A700019P49	RES DEPC 1/4W 10K	1
R078	A700019P44	RES DEPC 1/4W 3K9	1
R079	J706251P37	RES DEPC 1/1W 1K0	1
R080	A700019P25	RES DEPC 1/4W 100R	1
R081	J706056P1	RES DEPC 1/2W 1R0	1
R082	A700019P54	RES DEPC 1/4W 27K	1
R083	A700019P40	RES DEPC 1/4W 1K8	1
R084	A700019P5	RES DEPC 1/4W 2R2	1
R085	A700019P22	RES DEPC 1/4W 56R	1
R086	A700019P37	RES DEPC 1/4W 1K0	1
R087	J706251P30	RES DEPC 1/1W 270R	1
R088	A700019P46	RES DEPC 1/4W 5K6	1
R089	A700019P47	RES DEPC 1/4W 6K8	1
R090	A700019P53	RES DEPC 1/4W 22K	1
R091	A700019P34	RES DEPC 1/4W 560R	1
R092	A700019P20	RES DEPC 1/4W 39R	1
R093	A700019P53	RES DEPC 1/4W 22K	1
T001	K805566G1	XFERM ASM IU 903	1
U001	J708621P1	CPLR OPTO PC 847	1
U002	J708621P1	CPLR OPTO PC 847	1
U003	J708621P1	CPLR OPTO PC 847	1
U004	A700176P1	IC DIG BUFR 4049 U	1
U005	A700176P1	IC DIG BUFR 4049 U	1
U006	A70029P202	IC DIG ARITH 4532	1
U007	J706247P1	IC PROM FUSE 5330	1
U008	J706247P1	IC PROM FUSE 5330	1
U009	J706216P18	RES NETW 4X 4K7	1
U010	J706216P18	RES NETW 4X 4K7	1
U011	J706216P18	RES NETW 4X 4K7	1

DATE: 9/16/1987

Pos	Code No	Description	Qt
U012	J706216P14	RES NETW 9 X 47K 5% G3	1
U013	J706216P18	RES NETW 4 X 4K7 5% G2/G3	1
U014	J706216P20	RES NETW 5 X 4K7 5% G2/G3	1
U015	J706216P12	RES NETW 8 X 47K 5% G3	1
U016	J706216P12	RES NETW 8 X 47K 5% G3	1
W001	A700184P1	RES WIRE JMPR OR JUMPER	1
	M905870P1R2	BD PW	1
	J706903P1	NON ELECTRICAL PARTS	1
	J706903P2	FUSE HOLDER5.OX20.0MM	1
		FUSE HOLDER5.OX20.0MM	1
	**	NOT PART OF MOUNTED BOARD	

Pos	Code No	Description	Qt

CHAPTER
CHAPITRE
KAPITEL

6

Storno

FREQUENCY CALCULATION AND PROGRAMMING

CQF9000

The CQF9000 base stations are available in two versions of channel frequency generation, the multiplier versions and the synthesizer versions.

The multiplier versions use two crystal oscillators, the RX oscillator and the TX oscillator, for each channel. The quartz crystal frequency for each oscillator is calculated using the appropriate formulae for the frequency band.

The synthesizer versions have the channel fre-

quency data stored in two Programmable Read Only Memories (PROM), one for receiver channels and one for transmitter channels.

The transmitter and receiver each employs crystal oscillator in the phase locked loop mixer and these oscillator frequencies are calculated using the appropriate formulae for the frequency band. When the mixer oscillators are operating the synthesizer module is capable of generating up to 256 contiguous channels of which 12 can be selected by the data stored in the prom.

CRYSTAL FREQUENCIES FOR MULTIPLIER VERSIONS

The following notations are used in the formulae: f_X = crystal frequency
 f_A = channel frequency

CQF933x 68-88 MHz

Transmitter

$$f_X = \frac{f_A}{4} \text{ MHz}$$

Receiver

$$f_X = \frac{f_A + 21.4}{2} \text{ MHz}$$

CQF911x 138-174 MHz

Transmitter

$$f_X = \frac{f_A}{3} \text{ MHz}$$

Receiver

$$f_X = \frac{f_A - 21.4}{3} \text{ MHz}$$

CQF955x 360-410 MHz and
 CQF966x 403-470 MHz

Transmitter

$$f_X = \frac{f_A}{9} \text{ MHz}$$

Receiver

$$f_X = \frac{f_A - 21.4}{9} \text{ MHz}$$

CRYSTAL FREQUENCIES FOR SYNTHESIZER VERSIONS

The following notations are used in the formulae:

- f_x = crystal frequency (mixer)
- f_{AL} = lower channel frequency
- f_{AH} = higher channel frequency

CQF933x 68-88 MHz

CQF911x 138-174 MHz

CQF955x 360-410 MHz and
CQF966x 403-470 MHzTransmitter

$$f_x = \frac{f_{AH} + 12.8}{2} \text{ MHz}$$

Transmitter

$$f_x = \frac{f_{AL} - 12.8}{3} \text{ MHz}$$

Transmitter

$$f_x = \frac{f_{AL} - 12.8}{9} \text{ MHz}$$

Receiver

$$f_x = \frac{f_{AH} + 34.2}{2} \text{ MHz}$$

Receiver

$$f_x = \frac{f_{AL} - 34.2}{3} \text{ MHz}$$

Receiver

$$f_x = \frac{f_{AL} - 34.2}{9} \text{ MHz}$$

SYNTHESIZER DATA CALCULATION

The synthesizer data are stored in two proms one for the receiver channels and one for the transmitter channels.

When the channel frequencies are known and the mixer crystal frequencies have been calculated the prom data are calculated and programmed as follows:

1. The receiver and transmitter channels are noted and the lower and higher of each group are marked.
2. Using the actual channel frequency and the higher or lower channel frequency the prom bit pattern is calculated. A set of algorithms is used and the calculation is done using both the transmitter and the receiver frequency.
3. When all bits for a channel have been found they are negated (0=1, 1=0) and converted to hexadecimal notation.
4. The calculation procedure is repeated for each channel.
5. The hexadecimal data are assigned to the prom addresses corresponding to the channel numbers and loaded into the programming equipment.
6. The receiver and transmitter proms are programmed and inserted in the IU903 interface unit.

PROM DATA CALCULATION

The following notations are used in the algorithm set: f_{AH} = higher channel frequency
 f_{An} = actual channel frequency for channel n (1-12)
 f_{AL} = lower channel frequency
 N_0-N_7 = values depending on type of synthesizer
 Q_0-Q_7 = synthesizer data bits

CQF933x 68-88 MHz
 $A = f_{AH} - f_{An}$ (kHz)

CQF911x 138-174 MHz, CQF955x 360-410 MHz, CQF966x 403-470 MHz
 $A = f_{An} - f_{AL}$

- 1: IF $A - N_7 \geq 0$ THEN $Q_7 = 1$ ELSE $Q_7 = 0$
- 2: $B = A - (N_7 \times Q_7)$
- 3: IF $B - N_6 \geq 0$ THEN $Q_6 = 1$ ELSE $Q_6 = 0$
- 4: $C = B - (N_6 \times Q_6)$
- 5: IF $C - N_5 \geq 0$ THEN $Q_5 = 1$ ELSE $Q_5 = 0$
- 6: $D = C - (N_5 \times Q_5)$
- 7: IF $D - N_4 \geq 0$ THEN $Q_4 = 1$ ELSE $Q_4 = 0$
- 8: $E = D - (N_4 \times Q_4)$
- 9: IF $E - N_3 \geq 0$ THEN $Q_3 = 1$ ELSE $Q_3 = 0$
- 10: $F = E - (N_3 \times Q_3)$
- 11: IF $F - N_2 \geq 0$ THEN $Q_2 = 1$ ELSE $Q_2 = 0$
- 12: $G = F - (N_2 \times Q_2)$
- 13: IF $G - N_1 \geq 0$ THEN $Q_1 = 1$ ELSE $Q_1 = 0$
- 14: $H = G - (N_1 \times Q_1)$
- 15: IF $H - N_0 \geq 0$ THEN $Q_0 = 1$ ELSE $Q_0 = 0$

Synthesizer type	FS907	FS908	FS909	FS9010	FS9011
Channel Spacing	6.25 kHz	10.0 kHz	12.5 kHz	20.0 kHz	25.0 kHz
Value of N					
N_0	6.25	10.0	12.5	20.0	25.0
N_1	12.5	20.0	25.0	40.0	50.0
N_2	25.0	40.0	50.0	80.0	100.0
N_3	50.0	80.0	100.0	160.0	200.0
N_4	100.0	160.0	200.0	320.0	400.0
N_5	200.0	320.0	400.0	640.0	800.0
N_6	400.0	640.0	800.0	1280.0	1600.0
N_7	800.0	1280.0	1600.0	NOTE	3200.0

NOTE: Q_7 is always 1 in FS9010 and the maximum number of channels that can be generated is 128.

DATA SHEET

TRANSMITTER

CHANNEL	CALCULATED BITS								PROM BITS								PROM	
	Q7	Q6	Q5	Q4	Q3	Q2	Q1	Q0	$\bar{Q}7$	$\bar{Q}6$	$\bar{Q}5$	$\bar{Q}4$	$\bar{Q}3$	$\bar{Q}2$	$\bar{Q}1$	$\bar{Q}0$	HEX	ADDRESS
1																		00
2																		01
3																		02
4																		03
5																		04
6																		05
7																		06
8																		07
9																		08
10																		09
11																		0A
12																		0B

RECEIVER

CHANNEL	CALCULATED BITS								PROM BITS								PROM	
	Q7	Q6	Q5	Q4	Q3	Q2	Q1	Q0	$\bar{Q}7$	$\bar{Q}6$	$\bar{Q}5$	$\bar{Q}4$	$\bar{Q}3$	$\bar{Q}2$	$\bar{Q}1$	$\bar{Q}0$	HEX	ADDRESS
1																		00
2																		01
3																		02
4																		03
5																		04
6																		05
7																		06
8																		07
9																		08
10																		09
11																		0A
12																		0B

PROM PART NO. J706247P1 32 x 8 bits Fusible link

BINARY TO HEX CONVERSION

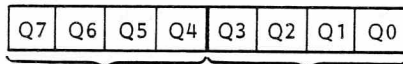

MSD LSD
 HEX HEX

MSD= Most Significant Digit
 LSD= Least Significant Digit

BINARY	HEX
0 0 0 0 =	0
0 0 0 1 =	1
0 0 1 0 =	2
0 0 1 1 =	3
0 1 0 0 =	4
0 1 0 1 =	5
0 1 1 0 =	6
0 1 1 1 =	7
1 0 0 0 =	8
1 0 0 1 =	9
1 0 1 0 =	A
1 0 1 1 =	B
1 1 0 0 =	C
1 1 0 1 =	D
1 1 1 0 =	E
1 1 1 1 =	F

CALCULATION EXAMPLE

Example: CQF9112 SYNTHESIZER FS9011

- CHANNEL 1: Receiver freq. : 163.525 MHz (f_{AL})
- CHANNEL 2: Receiver freq. : 163.675 MHz (f_{AH})
- CHANNEL 1: Transmitter freq. : 168.525 MHz (f_{AL})
- CHANNEL 2: Transmitter freq. : 168.575 MHz (f_{AH})

Transmitter mixer crystal frequency:

$$f_x = \frac{f_{AL} - 12.8}{3} \text{ MHz} = \frac{168.5250 - 12.8}{3} = \underline{51.908333 \text{ MHz}}$$

Receiver mixer crystal frequency:

$$f_x = \frac{f_{AL} - 34.2}{3} \text{ MHz} = \frac{163.5250 - 34.2}{3} = \underline{43.108333 \text{ MHz}}$$

Synthesizer data, Transmitter

$f_{AL} = 168.5250$
 $F_{A1} = 168.5250$
 $F_{A2} = 168.5750$

CHANNEL 1:

$A = f_{A1} - f_{AL}$	$168525 - 168525$	$= 0$	
1: $A - N_7$	$= 0 - 3200$	$= -3200$	$Q7 = 0$
2: $B = A - (N_7 \times Q7)$	$= 0 - (3200 \times 0)$	$= 0$	
3: $B - N_6$	$= 0 - 1600$	$= -1600$	$Q6 = 0$
4: $C = B - (N_6 \times Q6)$	$= 0 - (1600 \times 0)$	$= 0$	
5: $C - N_5$	$= 0 - 800$	$= -800$	$Q5 = 0$
6: $D = C - (N_5 \times Q5)$	$= 0 - (800 \times 0)$	$= 0$	
7: $D - N_4$	$= 0 - 400$	$= -400$	$Q4 = 0$
8: $E = D - (N_4 \times Q4)$	$= 0 - (400 \times 0)$	$= 0$	
9: $E - N_3$	$= 0 - 200$	$= -200$	$Q3 = 0$
10: $F = E - (N_3 \times Q3)$	$= 0 - (200 \times 0)$	$= 0$	
11: $F - N_2$	$= 0 - 100$	$= -100$	$Q2 = 0$
12: $G = F - (N_2 \times Q2)$	$= 0 - (100 \times 0)$	$= 0$	
13: $G - N_1$	$= 0 - 50$	$= -50$	$Q1 = 0$
14: $H = G - (N_1 \times Q1)$	$= 0 - (50 \times 0)$	$= 0$	
15: $H - N_0$	$= 0 - 25$	$= -25$	$Q0 = 0$

CHANNEL 2:

$A = f_{A2} - f_{AL}$	$168575 - 168525$	$= 50$	
1: $A - N_7$	$= 50 - 3200$	$= -3150$	$Q7 = 0$
2: $B = A - (N_7 \times Q7)$	$= 50 - (3200 \times 0)$	$= 50$	
3: $B - N_6$	$= 50 - 1600$	$= -1550$	$Q6 = 0$
4: $C = B - (N_6 \times Q6)$	$= 50 - (1600 \times 0)$	$= 50$	
5: $C - N_5$	$= 50 - 800$	$= -750$	$Q5 = 0$
6: $D = C - (N_5 \times Q5)$	$= 50 - (800 \times 0)$	$= 50$	
7: $D - N_4$	$= 50 - 400$	$= -350$	$Q4 = 0$
8: $E = D - (N_4 \times Q4)$	$= 50 - (400 \times 0)$	$= 50$	
9: $E - N_3$	$= 50 - 200$	$= -150$	$Q3 = 0$
10: $F = E - (N_3 \times Q3)$	$= 50 - (200 \times 0)$	$= 50$	
11: $F - N_2$	$= 50 - 100$	$= -50$	$Q2 = 0$
12: $G = F - (N_2 \times Q2)$	$= 50 - (100 \times 0)$	$= 50$	
13: $G - N_1$	$= 50 - 50$	$= 0$	$Q1 = 1$
14: $H = G - (N_1 \times Q1)$	$= 50 - (50 \times 0)$	$= 0$	
15: $H - N_0$	$= 0 - 25$	$= -25$	$Q0 = 0$

Synthesizer data, Receiver

$f_{AL} = 163.525 \text{ MHz}$

$f_{A1} = 163.525 \text{ MHz}$

$f_{A2} = 163.675 \text{ MHz}$

CHANNEL 1:

$$A = f_{A1} - f_{AL} \quad 163525 - 163525 = 0$$

$$1: A - N_7 = 0 - 3200 = -3200 \quad Q7 = 0$$

$$2: B = A - (N_7 \times Q7) = 0 - (3200 \times 0) = 0$$

$$3: B - N_6 = 0 - 1600 = -1600 \quad Q6 = 0$$

$$4: C = B - (N_6 \times Q6) = 0 - (1600 \times 0) = 0$$

$$5: C - N_5 = 0 - 800 = -800 \quad Q5 = 0$$

$$6: D = C - (N_5 \times Q5) = 0 - (800 \times 0) = 0$$

$$7: D - N_4 = 0 - 400 = -400 \quad Q4 = 0$$

$$8: E = D - (N_4 \times Q4) = 0 - (400 \times 0) = 0$$

$$9: E - N_3 = 0 - 200 = -200 \quad Q3 = 0$$

$$10: F = E - (N_3 \times Q3) = 0 - (200 \times 0) = 0$$

$$11: F - N_2 = 0 - 100 = -100 \quad Q2 = 0$$

$$12: G = F - (N_2 \times Q2) = 0 - (100 \times 0) = 0$$

$$13: G - N_1 = 0 - 50 = -50 \quad Q1 = 0$$

$$14: H = G - (N_1 \times Q1) = 0 - (50 \times 0) = 0$$

$$15: H - N_0 = 0 - 25 = -25 \quad Q0 = 0$$

CHANNEL 2:

$$A = f_{A2} - f_{AL} \quad 163675 - 163525 = 150$$

$$1: A - N_7 = 150 - 3200 = -3050 \quad Q7 = 0$$

$$2: B = A - (N_7 \times Q7) = 150 - (3200 \times 0) = 150$$

$$3: B - N_6 = 150 - 1600 = -1450 \quad Q6 = 0$$

$$4: C = B - (N_6 \times Q6) = 150 - (1600 \times 0) = 150$$

$$5: C - N_5 = 150 - 800 = -650 \quad Q5 = 0$$

$$6: D = C - (N_5 \times Q5) = 150 - (800 \times 0) = 150$$

$$7: D - N_4 = 150 - 400 = -250 \quad Q4 = 0$$

$$8: E = D - (N_4 \times Q4) = 150 - (400 \times 0) = 150$$

$$9: E - N_3 = 150 - 200 = -50 \quad Q3 = 0$$

$$10: F = E - (N_3 \times Q3) = 150 - (200 \times 0) = 150$$

$$11: F - N_2 = 150 - 100 = 50 \quad Q2 = 1$$

$$12: G = F - (N_2 \times Q2) = 150 - (100 \times 1) = 50$$

$$13: G - N_1 = 150 - 50 = 100 \quad Q1 = 1$$

$$14: H = G - (N_1 \times Q1) = 50 - (50 \times 1) = 0$$

$$15: H - N_0 = 0 - 25 = -25 \quad Q0 = 0$$

DATA SHEET

TRANSMITTER

CHANNEL	CALCULATED BITS								PROM BITS								HEX	PROM ADDRESS
	Q7	Q6	Q5	Q4	Q3	Q2	Q1	Q0	$\bar{Q}7$	$\bar{Q}6$	$\bar{Q}5$	$\bar{Q}4$	$\bar{Q}3$	$\bar{Q}2$	$\bar{Q}1$	$\bar{Q}0$		
1	0	0	0	0	0	0	0	0	1	1	1	1	1	1	1	1	FF	00
2	0	0	0	0	0	0	1	0	1	1	1	1	1	1	0	1	FD	01
3																		02
4																		03
5																		04
6																		05
7																		06
8																		07
9																		08
10																		09
11																		0A
12																		0B

RECEIVER

CHANNEL	CALCULATED BITS								PROM BITS								HEX	PROM ADDRESS
	Q7	Q6	Q5	Q4	Q3	Q2	Q1	Q0	$\bar{Q}7$	$\bar{Q}6$	$\bar{Q}5$	$\bar{Q}4$	$\bar{Q}3$	$\bar{Q}2$	$\bar{Q}1$	$\bar{Q}0$		
1	0	0	0	0	0	0	0	0	1	1	1	1	1	1	1	1	FF	00
2	0	0	0	0	0	1	1	0	1	1	1	1	1	0	0	1	F9	01
3																		02
4																		03
5																		04
6																		05
7																		06
8																		07
9																		08
10																		09
11																		0A
12																		0B

ALTERNATIVE METHOD FOR SYNTHESIZER CALCULATION

CQF9000

The following notations are used in the formulae:

- F_n = Frequency of channel (n) to be calculated.
 F_{AL} = Frequency of lower channel
 F_{AH} = Frequency of higher channel
 F_x = Crystal frequency of mixer
 R = Reference frequency step per channel
 N_n = Prom data (decimal) for channel n.

Procedure

Calculate the mixer crystal frequency.

Calculate N_n for each channel

Convert N_n to hexadecimal notation

Program N_n in PROM address (n - 1),

e.g. channel 1 = address 00_H , channel 2 = address 01_H .

SYNTHESIZER CONSTANTS

FS909	$R = 0.0125$	$f_z = 12.8$
FS9010	$R = 0.02$	$f_z = 10.24$
FS9011	$R = 0.025$	$f_z = 12.8$

CQF9110 FORMULAE

TX:

$$F_x = \frac{F_{AL} - f_z}{3} \text{ MHz}$$

RX:

$$F_x = \frac{F_{AL} - 21.4 - f_z}{3} \text{ MHz}$$

$$N_n = 255 - \left(\frac{F_n - F_{AL}}{R} \right)$$

CQF9330 FORMULAE

TX:

$$F_x = \frac{F_{AH} + f_z}{2} \text{ MHz}$$

RX:

$$F_x = \frac{F_{AH} + 21.4 + f_z}{2}$$

$$N_n = 255 - \left(\frac{F_{AH} - F_n}{R} \right)$$

CQF9550 AND CQF9660 FORMULAE

TX:

$$F_x = \frac{F_{AL} - f_z}{9} \text{ MHz}$$

RX:

$$F_x = \frac{F_{AL} - 21.4 - f_z}{9} \text{ MHz}$$

$$N_n = 255 - \left(\frac{F_n - F_{AL}}{R} \right)$$

FORMULAE FOR CALCULATION OF DATA USING AVAILABLE CRYSTALS

CQF9110

TX:

$$N_n = 255 - \left(\frac{F_n - 3F_x - f_z}{R} \right)$$

RX:

$$N_n = 255 - \left(\frac{F_n - 3F_x - 21.4 - f_z}{R} \right)$$

Requirement: $255 \geq N_n \geq 0$ (N_n rounded to nearest integer)

CQF9330

TX:

$$N_n = 255 - \left(\frac{2F_x + f_z - F_n}{R} \right)$$

RX:

$$N_n = 255 - \left(\frac{2F_x + 21.4 - f_z - F_n}{R} \right)$$

Requirement: $255 \geq N_n \geq 0$ (rounded to nearest integer)

CQF9550 AND CQF9660

TX:

$$N_n = 255 - \left(\frac{F_n - 9F_x - f_z}{R} \right)$$

RX:

$$N_n = 255 - \left(\frac{F_n - 9F_x - 21.4 - f_z}{R} \right)$$

Requirement: $255 \geq N_n \geq 0$ (rounded to nearest integer)

Example 1:

Radiotype: CQF9112

Synthesizer: FS9011

$$TX_1 = 150.050 \quad (F_{AL})$$

$$TX_2 = 150.150 \quad (F_{AH})$$

$$RX_1 = 160.050 \quad (F_{AL})$$

$$RX_2 = 160.150 \quad (F_{AH})$$

$$R = 0.025 \quad f_z = 12.8$$

TX:

$$F_x = \frac{150.050 - 12.8}{3} = \underline{45.75 \text{ MHz}}$$

$$N_1 = 255 - \left(\frac{150.050 - 3 \times 45.75 - 12.8}{0.025} \right) = 255 \quad (FF_H)$$

$$N_2 = 255 - \left(\frac{150.150 - 3 \times 45.75 - 12.8}{0.025} \right) = 251 \quad (FB_H)$$

RX:

$$F_x = \frac{160.050 - 21.4 - 12.8}{0.025} = \underline{41.95 \text{ MHz}}$$

$$N_1 = 255 - \left(\frac{160.050 - 3 \times 41.95 - 21.4 - 12.8}{0.025} \right) = 255 \quad (FF_H)$$

$$N_2 = 255 - \left(\frac{160.150 - 3 \times 41.95 - 21.4 - 12.8}{0.025} \right) = 251 \quad (FB_H)$$

<u>Prom data</u>		<u>TX</u>	<u>RX</u>
Address	00	FF	FF
	01	FB	FB

Example 2:

Radiotype: CQF9112

Synthesizer: FS9011

Available TX mixer crystal $F_x = 45.35000$

Available RX mixer crystal $F_x = 40.15000$

$$\begin{array}{lll} \text{TX}_1 = 150.250 & (F_1) & f_z = 12.8 \\ \text{TX}_2 = 150.450 & (F_2) & R = 0.025 \\ \text{RX}_1 = 155.750 & (F_1) & \\ \text{RX}_2 = 155.950 & (F_2) & \end{array}$$

TX:

$$N_1 = 255 - \left(\frac{150.250 - 3 \times 45.35 - 12.8}{0.025} \right) = 199 \text{ (C7}_H\text{)}$$

$$N_2 = 255 - \left(\frac{150.450 - 3 \times 45.35 - 12.8}{0.025} \right) = 191 \text{ (BF}_H\text{)}$$

RX:

$$N_1 = 255 - \left(\frac{155.750 - 3 \times 40.15 - 21.4 - 12.8}{0.025} \right) = 211 \text{ (D3}_H\text{)}$$

$$N_2 = 255 - \left(\frac{155.950 - 3 \times 40.15 - 21.4 - 12.8}{0.025} \right) = 203 \text{ (CB}_H\text{)}$$

<u>Prom data</u>		<u>TX</u>	<u>RX</u>
Address	00	C7 _i	D3
	01	BF	CB

CHAPTER
CHAPITRE
KAPITEL

7

Storno

ADJUSTMENT PROCEDURE

CQF9xxx

This adjustment procedure covers the simplex and duplex versions of the Stornophone CQF9000 series with the following nomenclature:

CQF9xx0D	Duplex
CQF9xx0S	Simplex

Three versions of frequency capacities are also covered.

- Z - Synthesized channel generation, full channels
- S - Synthesized channel generation, interleaved channels
- M - Multiplier generation

The adjustment procedure is divided into a number of steps and where differing for the version there will be a number of parallel columns. The heading of each column indicates which version the procedure applies to.

The procedure comprises the following.

- Test set-up, RX-TX
- Measuring instruments
- Cables and connectors
- Adjustment tools
- Central Metering connectors, CM
- Voltage regulator checks
- Receiver adjustments
- Transmitter adjustments

When measuring voltages on the central metering connectors (RX CM, TX CM and PA CM), it is convenient to use a voltmeter with a sensitivity of 20 Kohm/V.

All central metering voltages stated for reference are measured with a 20 Kohm/V meter and if another meter sensitivity is used readings must be considered for reference only.

TEST SET-UP

The test Set-up is shown schematically for both receiver and transmitter and diagrams which show the location of adjustable components and central metering connectors are placed at the end of this chapter.

MEASURING INSTRUMENTS

RF Signal generator	10-470 MHz
Multimeter	20 Kohm/V
AC Voltmeter	$Z_i > 20$ Kohm/V
Distortion meter with psophometric filter	
Deviation meter	68-470 MHz
Frequency counter	10-470 MHz
AF Signal generator	0-5 kHz
RF Power meter	0-40 W
DC Power supply	10-20 V, Current limiter adjustable 0.1-10 A
DC Amperemeter	0-0.1 A
DC Amperemeter	0-10 A
Adjustment tool kit	J707383G1
AF load resistor	600 ohm

CENTRAL METERING CONNECTORS (CM)

POWER AMPLIFIER METERING CONNECTOR

PA	Function	Connect meter to	
		-	+
1.	A-		
2.	A+	1 - 2	
3.	Not used		
4.	Final current	4 - 2	
5.	Drive current	6 - 2	
6.	Not used		
7.	Not used		
8.	Power control	1 - 8	
9.	Forward power	1 - 9	
10.	Input drive	1 - 10	

TX CENTRAL METERING (J21)

	FUNCTION			Connect Voltmeter
	EX911/EX931	PL962	EX9x2/EX961	
	1. Gnd	Gnd	Gnd	
2. VCO FS	VCO FS	Not used	1 - 2	
3. +9 V	+9 V	+9 V	1 - 3	
4. Lock FS	Lock FS	Not used	1 - 4	
5. BP1	TX status	Not used	1 - 5	
6. BP2	TX PLL Tune	BP2	1 - 6	
7. Not used	OSC FS	Not used	1 - 7	
8. Not used	TX Filter	Not used	1 - 8	
9. Mixer	TX Tripler	Not used	1 - 9	
10. OSC	OSC	OSC	1 - 10	

RX CENTRAL METERING (J20)

		SYNTHESIZER VERSION		MULTIPLIER VERSION			Connect Voltmeter
		FG912/FG932	PL961	FG913	FG933	FG961	
		1.		Gnd	Gnd	Gnd	
2.		FS VCO	FS VCO	Not used	Not used	Not used	1 - 2
3.	+9 V	+9 V	+9 V	+9 V	+9 V	+9 V	1 - 3
4.	IF	-	-	-	-	-	1 - 4
5.	RX Mixer	-	-	-	-	-	1 - 5
6.		Filter	RX PLL Tune	Not used	Not used	RX Tripler	1 - 6
7.		Not used	RX lock det.	Not used	Not used	Not used	1 - 7
8.		Mixer	RX Filter	Filter	Not used	Not used	1 - 8
9.		Not used	RX Tripler	Not used	Not used	Not used	1 - 9
10.		OSC	OSC	OSC	OSC	OSC	1 - 10

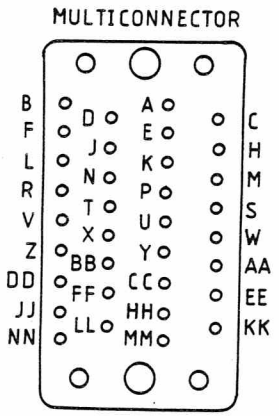
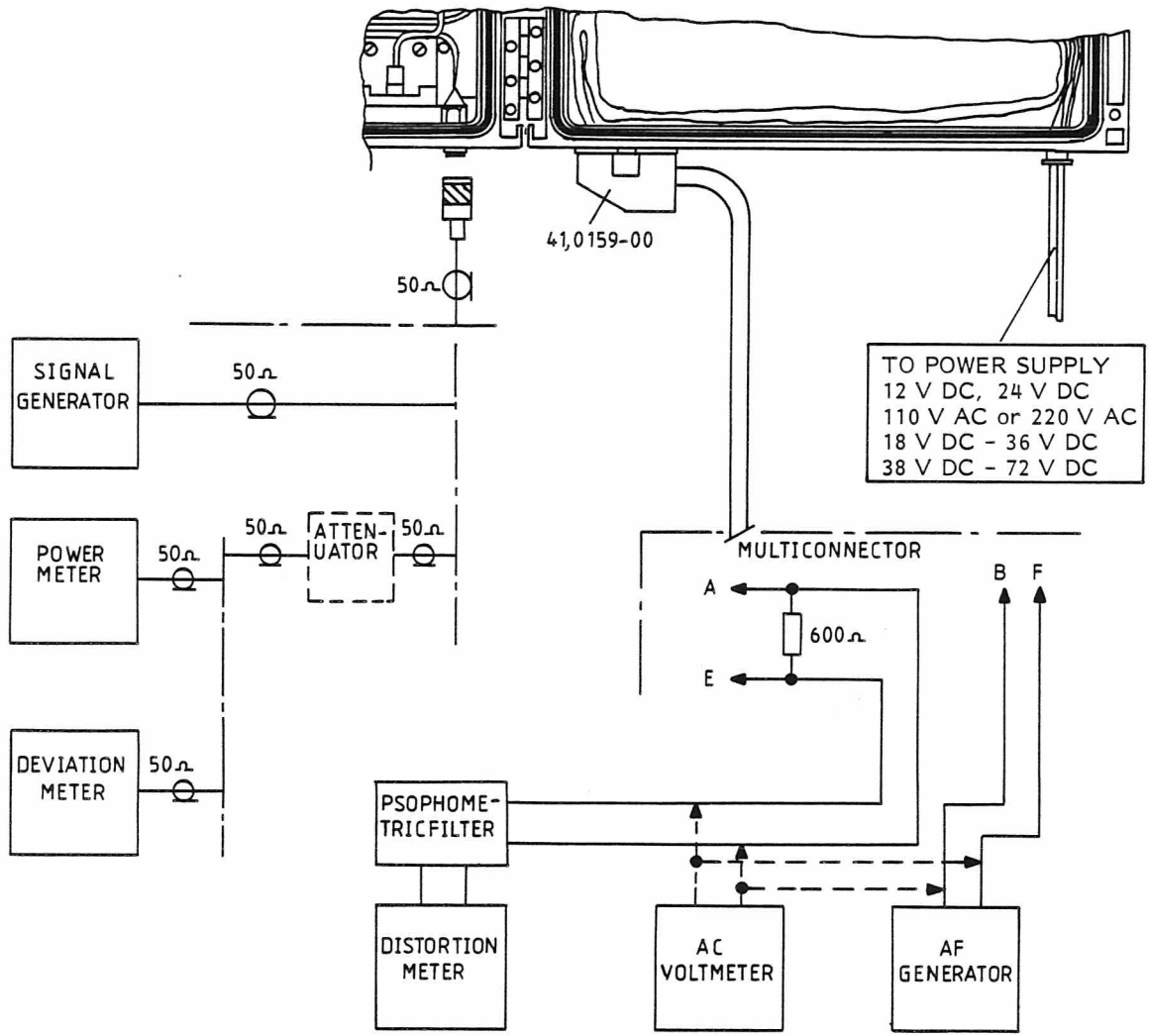

CHANNEL	SHORT
1	D - DD
2	J - DD
3	N - DD
4	T - DD
5	X - DD
6	BB - DD
7	FF - DD
8	LL - DD
9	D+Z - DD
10	J+Z - DD
11	N+Z - DD
12	T+Z - DD

CHANNEL SELECTION

CQF900
TEST SET-UP
D403.948

ADJUSTMENT OVERVIEW

CQF9110 AND CQF9330

VOLTAGE ADJUSTMENT AND CHECKING

Supply voltage check Voltage Regulation Check
--

CHANNEL FREQUENCY GENERATION CHECK

Frequency Synthesizer Adjustment

RECEIVER ADJUSTMENT

Receiver Injection Signal Alignment	
Multiplier version FG9x3	Synthesizer version FG9x2
Receiver Frequency Fine Tuning	
Multiplier version FG9x3	Synthesizer version FG9x2
Receiver Front-end Alignment Simplex RX911/RC912 + Duplex RC911 Simplex + Duplex RC931	
IF Fine Tuning and Audio Power Setting	
Checking Receiver Sensitivity	
Squelch Adjustment	
Checking Receiver Current Consumption	

TRANSMITTER ADJUSTMENT

EXCITER ALIGNMENT	
Multiplier version EX9x2	Synthesizer version EX9x1
FREQUENCY ADJUSTMENT	
Multiplier version EX9x2	Synthesizer version EX9x1
RF POWER ADJUSTMENT	
MODULATION ADJUSTMENT Synthesizer EX9x1 + Multiplier EX9x2	
MODULATION SENSITIVITY CHECK	
MEASURING TRANSMITTER CURRENT CONSUMPTION	

CQF9550

VOLTAGE ADJUSTMENT AND CHECKING

Supply voltage check Voltage Regulation Check
--

CHANNEL FREQUENCY GENERATION CHECK

Frequency Synthesizer Adjustment

RECEIVER ADJUSTMENT

Receiver Injection Signal Alignment Synthesizer PL951
Receiver Frequency Fine Tuning Synthesizer PL951
Receiver Front-end Alignment Simplex RC953 and Duplex RC953 + BF951
IF Fine Tuning and Audio Power Setting Simplex/Duplex RC953
Checking Receiver Sensitivity Simplex RC953 Duplex RC953 + BF951
Squelch Adjustment
Checking Receiver Current Consumption

TRANSMITTER ADJUSTMENT

EXCITER ALIGNMENT Simplex/Duplex PL952
FREQUENCY ADJUSTMENT Simplex/Duplex PL952
RF POWER ADJUSTMENT
MODULATION ADJUSTMENT Simplex/Duplex PL952
MODULATION SENSITIVITY CHECK
MEASURING TRANSMITTER CURRENT CONSUMPTION

ADJUSTMENT OVERVIEW

CQF9660

VOLTAGE ADJUSTMENT AND CHECKING

Supply voltage check Voltage Regulation Check
--

CHANNEL FREQUENCY GENERATION CHECK

Frequency Synthesizer Adjustment

RECEIVER ADJUSTMENT

Receiver Injection Signal Alignment	
Synthesizer version PL961	Multiplier version FG961
Receiver Frequency Fine Tuning	
Synthesizer version PL961	Multiplier version FG961
Receiver Front-end Alignment	
Simplex RC969 /RC962 and Duplex RC969 + BF961	
IF Fine Tuning and Audio Power Setting	
Simplex RC962	Simplex/Duplex RC969
Checking Receiver Sensitivity	
Simplex RC969/RC962	Duplex RC969 + BF961
Squelch Adjustment	
Checking Receiver Current Consumption	

TRANSMITTER ADJUSTMENT

EXCITER ALIGNMENT	
Simplex/Duplex PL962	Multiplier version EX961
FREQUENCY ADJUSTMENT	
Simplex/Duplex PL962	Multiplier version EX961
RF POWER ADJUSTMENT	
MODULATION ADJUSTMENT	
Simplex/Duplex PL962	Multiplier version EX961
MODULATION SENSITIVITY CHECK	
MEASURING TRANSMITTER CURRENT CONSUMPTION	

VOLTAGE ADJUSTMENT AND CHECKING

CQF9xxx

SUPPLY VOLTAGE CHECK (12 V DC ONLY)

Set the power supply voltage to 13.6 V (V_{BATT}).
Set the current limiter to 0.1 A.
Connect the power supply with reverse polarity to the equipment.
Measure the voltage across the power leads with a voltmeter. The meter should read less than 1.5 V.
Connect the power supply with correct polarity to the equipment and set the current limiter to 3 A.
Turn the radio on.

VOLTAGE REGULATION CHECK

The +9 V is measured between pin "1" and pin "3" on the CM connectors in the receiver tray and the transmitter tray.

Connect the voltmeter to 1 and 3 where +9 V is measured.
The meter should read 9.0 V.

These voltage measurements are not accurate enough for adjusting the voltages to be within the 0.5% tolerance. To do that a digital voltmeter must be used.
+9 V are adjusted with potentiometer R6 in VR903.

CHANNEL FREQUENCY GENERATION CHECK

CQF9xxx

FREQUENCY SYNTHESIZER FS90xx

Check the reference oscillator crystal frequency.

Type	Ref. freq. MHz	Output frequency Range	Channel Spacing
FS909	12.8000	12.8000-15.9875	12.5 kHz
FS9010	10.2400	12.8000-15.3400	20.0 kHz
FS9011	12.8000	12.8000-19.1750	25.0 kHz

Connect a frequency counter to the FS90xx output J1. Measure the frequency (output level 0 dBm).

For 12.5 kHz channel spacing the frequency should be a multiple of 12.5 kHz.

Example: 12.80000 MHz, 12.812500 MHz, etc.

For 20 kHz channel spacing the frequency should be a multiple of 20 kHz.

Example: 12.800000 MHz, 12.820000 MHz, etc.

For 25 kHz channel spacing the frequency should be a multiple of 25 kHz.

Example: 12.800000 MHz, 12.825000 MHz, etc.

The actual synthesizer frequency depends on the programming of the channels.

If the frequency is not correct adjust C5 in the FS to it is.

RECEIVER ADJUSTMENT

CQF9110

RECEIVER INJECTION SIGNAL ALIGNMENT

MULTIPLIER VERSION FG913

Select the center frequency channel.

Connect voltmeter to RX CM 1 and 10.

Detune L1, L2 and L3 (FG9x3) as much as possible.

Adjust L1 for maximum voltmeter reading.

Adjust then L2 for minimum voltmeter reading.

Adjust at last L3 for maximum voltmeter reading.

Select each channel one by one and adjust Lx2 in the corresponding oscillator for maximum voltmeter reading.

Connect the voltmeter to RX CM 1 and 6.

Adjust L1, L2 and L3 in FG913 for maximum voltmeter reading.

Repeat the adjustment until no further improvement is possible.

Approximately reading 0.4 V.

SYNTHESIZER VERSION FG912

Connect voltmeter to RX CM 1 and 10.

Preadjust all filter cores in FG912 according to the following diagram.

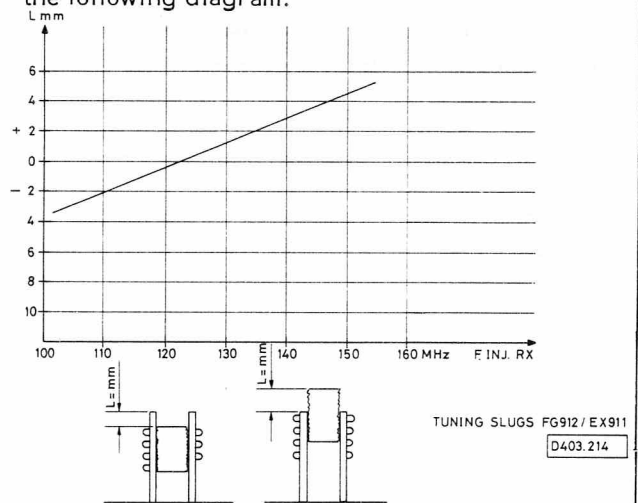

Adjust L_{XO} (L3 in X0905) in FG912 for maximum reading, at least 0.3 V.

Connect the voltmeter to RX CM 1 and 8.

Adjust L2, L3, and L4 for maximum voltmeter reading. The voltage peak is small and careful adjustment is necessary. Minimum increase in voltage reading should be at least 0.05 V.

Connect the voltmeter to RX CM 1 and 6.

Adjust L5, L6, L7, L8, L10, L11 and L12 in FG912 for maximum voltmeter reading.

Minimum increase in voltage reading should be 0.15 V.

Connect the voltmeter to RX CM 1 and 5.

Adjust L14 and L15 in FG912 for maximum voltmeter reading.

RC911/RC912

Connect the voltmeter to RX CM 1 and 5.

Adjust L5, L4 and L2 in RC911/RC912 for maximum voltmeter reading.

RECEIVER FREQUENCY FINE TUNING

MULTIPLIER VERSION FG913

Connect a frequency counter to the output of FG913, output level approx. 13 dBm.

Calculate the injection frequency:

$$F_{inj} = F_{ant} - 21.4 \text{ MHz}$$

Select each channel one by one and measure the frequency.

If the frequency is not correct adjust L_{X1} in the corresponding oscillator for correct frequency.

SYNTHESIZER VERSION FG912

Before adjustment of the injection frequency the synthesizer frequency should be checked, refer to Frequency Synthesizer Adjustment.

Connect a frequency counter to the output of FG912, J2, output level approx. +13 dBm.

Calculate the injection frequency:

$$F_{inj} = F_{ant} - 21.4 \text{ MHz}$$

Adjust L_{X2} ($L2$ in X0905) for correct injection frequency according to the temperature curve.

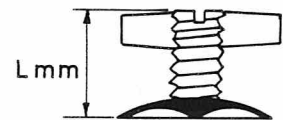
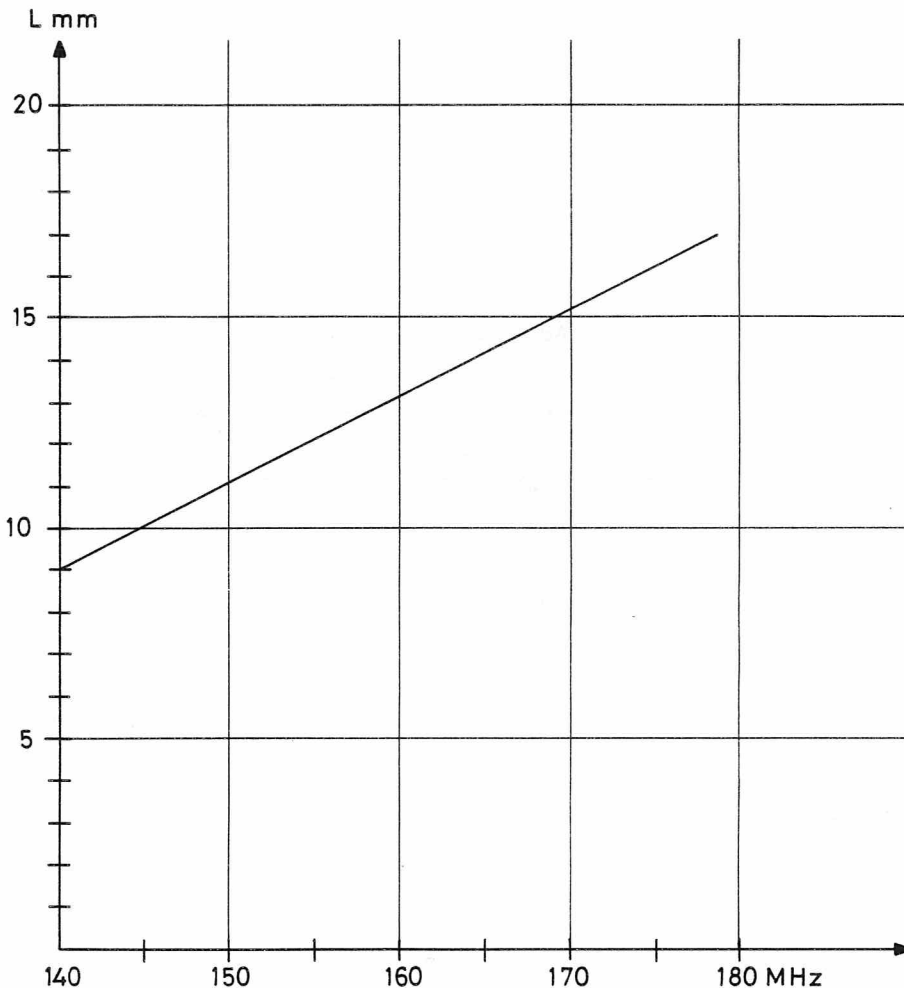

TUNING SLUGS RC911/RC912

D403.215

RECEIVER FRONT-END ALIGNMENT

SIMPLEX RC911/RC912 + DUPLEX RC911

This adjustment is only necessary if the helixfilters are out of adjustment or need readjustment.

Connect the signal generator to the antenna connector and set its frequency to the channel frequency.

Set the signal generator output level to 100 dB/1 uV or 100 mV.

Preadjust the tuning slugs TS1-TS2-TS3-TS4-TS5 to their approximate positions according to the graph page 2.

Connect the voltmeter to RX CM 1 and 4.

Adjust TS1-TS2-TS3-TS4, C2 and L2 for maximum voltmeter reading.

Decrease the signal generator level to be below the limiting point of the IF-amplifier as the sensitivity increases and before fine tuning.

Adjust TS5 to approximately the same height as TS4.

Detune TS2 and TS4 about 4 turns (~3 mm).

Adjust TS1, TS3, TS5 and C2 in RC911/RC912 for maximum voltmeter reading.

Adjust TS2 and TS4 for maximum voltmeter reading. Repeat the adjustment until no further improvement is possible.

Fine tune TS1, TS2, TS3, TS4, TS5, C1 and L2 for maximum voltmeter reading.

DUPLEX FILTER BF911

The duplex filter is factory adjusted to the ordered channel frequencies and need not be readjusted.



↓

IF FINE TUNING AND AUDIO POWER SETTING

IF AMPLIFIER ADJUSTMENT IA90x

Connect the signal generator to the antenna connector.
Set the generator frequency to the channel frequency and its output level to 1 mV EMF. Modulate the signal generator with 1 kHz to:

- 3.0 kHz for 25 kHz channel spacing
- 1.5 kHz for 12.5 kHz channel spacing
- 2.5 kHz for 20 kHz channel spacing

Connect the voltmeter to RX CM 1 and 4 and adjust L1, L2 and L3 to maximum reading. Connect a distortionmeter to the RX output multiconnector A-E, and adjust L1, L4 for minimum distortion.

SIMPLEX RC912

Adjust L2 in RC912 for minimum distortion.
Check the voltmeter reading for being approximately 0.5 V for 3 μ V.

SIMPLEX + DUPLEX RC911

Adjust L2 in RC911 for minimum distortion.
Connect the voltmeter to 1 and 4.
Check the voltmeter reading for being approximately 0.5 V for 10 μ V input signal (EMF).

AUDIO LINE LEVEL SETTING AA9018

Connect an AF voltmeter and a 600 ohm resistor to the RX output multiconnector A-E.
Set the output level from the signal generator to 1 mV EMF on the channel frequency. Modulate the signal generator with 1 kHz to:

- 3.0 kHz for 25 kHz channel spacing
- 1.5 kHz for 12.5 kHz channel spacing
- 2.5 kHz for 20 kHz channel spacing

Adjust the potentiometer R8 in AA9018 for a reading of 1.1 V RMS.

↓

CHECKING RECEIVER SENSITIVITY

Select the center channel.
 Set the signal generator to the receiver frequency and adjust the output level to 1 mV EMF.
 Connect a distortion meter with a psophometric filter and a 600 ohm resistor to the RX output multiconnector A-E.
 Measure the receiver sensitivity according to CEPT specifications (or EIA).

SIMPLEX RC911 OR RC912

CEPT SENSITIVITY SPECIFICATION, SIMPLEX

RC911/RC913:	RC912:
20 dB psophometric SINAD for V_{input} less than: 0.7 μ V EMF	0.4 μ V EMF

EIA SENSITIVITY SPECIFICATION

RC911	RC912
12 dB SINAD for V_{input} less than: 0.35 μ V ($\frac{1}{2}$ EMF)	0.2 μ V EMF

In radios with RC912 the sensitivity can be optimized by fine tuning TS2 for maximum SINAD.

DUPLEX RC911 + BF911

CEPT SENSITIVITY SPECIFICATION

With RC911 and BF911:
 20 dB psophometric SINAD for
 V_{input} less than 0.95 μ V EMF.

EIA SENSITIVITY SPECIFICATION

With RC911 and BF911:
 12 dB SINAD for
 V_{input} less than 0.45 μ V ($\frac{1}{2}$ EMF).

Measure the sensitivity on the highest and lowest channel frequencies.
 Compared with the measured sensitivity on the center channel the sensitivity degradation shall be less than 1 dB.

↓

SQUELCH ADJUSTMENT

Connect the signal generator to the antenna connector and set it to the receiver frequency. Modulate the signal generator with 1 kHz to:

- 3.0 kHz for 25 kHz channel spacing
- 1.5 kHz for 12.5 kHz channel spacing
- 2.5 kHz for 20 kHz channel spacing

Set the signal generator output level to the measured SINAD sensitivity.

Reduce the signal generator output 2 dB.

Adjust R_{SQ} (R4 on AA9018) until the squelch circuit just opens the receiver AF output.

Check that the squelch closes when the RF signal is removed from the antenna input.

CHECKING RECEIVER CURRENT CONSUMPTION

(12 V DC ONLY)

Measure the receiver current drain at $V_{BATT} = 13.6 \text{ V}$.

- | | |
|----------------|-----------------|
| Off condition: | less than 75 mA |
| Standby: | less than 1 A |

TRANSMITTER ADJUSTMENT

CQF9110

Connect a VHF power meter, 25 W (40 W), to the antenna connector.
Select the center channel. Key the transmitter when adjusting.

EXCITER ALIGNMENT

MULTIPLIER VERSION EX912

Connect the voltmeter to TX CM 1 and 10.
Adjust L1 for maximum voltmeter reading.
Adjust L2 for minimum voltmeter reading.
Connect the voltmeter to TX CM 1 and 6.
Adjust L1 and L2 for maximum voltmeter reading.
(approx 0.55 V).
Adjust Lx2 (output) in the corresponding oscillator XO906 for maximum voltmeter reading.
Repeat the adjustment of L1 and L2 for maximum until no further improvement is possible.

For multichannel radios select, one by one, all channels and adjust Lx2 in the oscillator corresponding to the selected channel for maximum voltmeter reading.

Connect the voltmeter to PA CM connector 1 and 10.
Adjust L9 and L10 in EX912 for maximum voltmeter reading.
Repeat the adjustment of L9 and L10 until no further improvement is possible.

SYNTHESIZER VERSION EX911

Connect the voltmeter to TX CM 1 and 10.
In EX911 adjust L12 for maximum voltmeter reading, L13 for minimum reading and L14 for maximum reading.
Minimum voltage reading should be at least 0.1 V.
Connect the voltmeter to TX CM 1 and 9.
In EX911 adjust L3 (XO), L12, L13 and L14 for maximum voltmeter reading.
Repeat the adjustment until no further improvement is possible.

Preset the tuning slugs of L3, L4, L5, L8, L9, L10 and L11 (EX911) to approximately the same position as L12. This ensures selection of the correct mixer output frequency.

Connect the voltmeter to TX CM 1 and 5.
Adjust L3, L4, L5 and L8 for maximum voltmeter reading.
Note that L8 can be in a position where absolutely maximum reading does not appear.
If so chose another setting of L8 and readjust.
Minimum reading should be at least 0.25 V.

Connect the voltmeter to TX CM 1 and 6.
Adjust L8 and L9 for maximum voltmeter reading.
If the output level is not high enough to give a meter deflection connect the voltmeter to PA CM connector 1 and 10.
Adjust L8, L9 and L11 for maximum voltmeter reading. The reading should be at least 0.3 V.

FREQUENCY ADJUSTMENT

MULTIPLIER VERSION EX912

Connect the frequency counter to the output of EX912 (J2) through an attenuator (output level 0.5 W).

Select the channels one by one and measure the frequency.

Key the transmitter. The channel cannot be changed while keying the transmitter. If necessary adjust the frequency with Lx1 in the corresponding oscillator.

Requirement: $F_{ant} \pm 50$ Hz

The frequency setting is temperature dependent according to the following graph.

Note:
The transmitter shall be unmodulated when adjusting the frequency.

SYNTHESIZER VERSION EX911

Before adjusting the transmitter frequency the synthesizer frequency should be checked, refer to Frequency Synthesizer Adjustment.

Connect the frequency counter to the output of EX911 (J2) through an attenuator (output level 0.5 W).

Key the transmitter.

Measure the frequency and if necessary adjust with Lx in EX911.

Requirement: $F_{ant} \pm 50$ Hz

The frequency setting is temperature dependent according to the following graph.

Note:
The transmitter shall be unmodulated when adjusting the frequency.

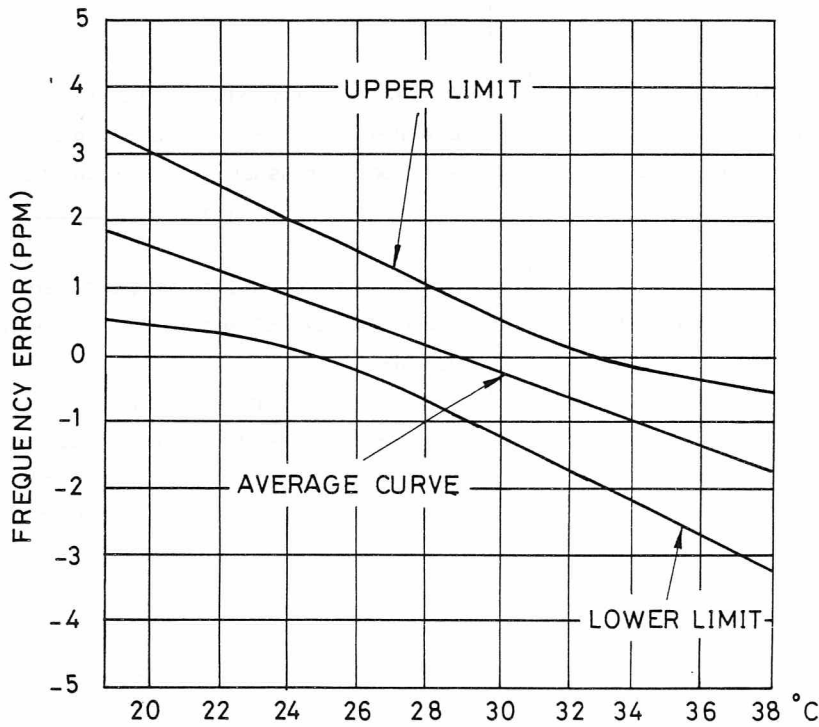

X0900 FREQUENCY ERROR CURVE

D403.172

↓

RF POWER ADJUSTMENT

Key the transmitter. Adjust R_{PA} in the power amplifier for rated output power.

MODULATION ADJUSTMENT

MULTIPLIER EX911/EX912

Connect an AF generator to the modulation input multiconnector B-F.
Set the AF generator frequency to 1 kHz and the output to 1.0 V.
Key the transmitter
Read the deviation on the deviation meter.

Change the AF frequency between 300 and 3000 Hz to find the peak deviation. At this frequency adjust R_{AA} for:

- ± 5.0 kHz for 25 kHz channel spacing
- ± 4.0 kHz for 20 kHz channel spacing
- ± 2.5 kHz for 12.5 kHz channel spacing

EX911

$R_{AA} = R18$

EX912

R_{AA} for XO1= R18

R_{AA} for XO2= R19

R_{AA} for XO3= R20

MODULATION SENSITIVITY CHECK

Set the AF generator frequency to 1000 Hz. Reduce the AF generator output until the deviation is:

- ±3 kHz for 25 kHz channel spacing
- ±2.4 kHz for 20 kHz channel spacing
- ±1.5 kHz for 12.5 kHz channel spacing

The AF generator level should be 100 mV ±3 dB.

MEASURING TRANSMITTER CURRENT CONSUMPTION (12 V DC ONLY)

Measure the current drain at $V_{BATT} = 13.6$ V.

Requirement:

- RF output 10 W (simplex): less than 4.5 A
- RF output 25 W (simplex): less than 7.5 A
- RF output 25 W (duplex): less than 11.5 A
- RF output 40 W (simplex): less than 11.0 A.

RECEIVER ADJUSTMENT

CQF9330

RECEIVER INJECTION SIGNAL ALIGNMENT

MULTIPLIER VERSION FG933

Select the center frequency channel.

Connect voltmeter to RX CM 1 and 10.

Detune L1, L2 and L3 (FG933) as much as possible.

Adjust L1 for maximum voltmeter reading.

Adjust then L2 for minimum voltmeter reading.

Adjust at last L3 for maximum voltmeter reading.

Select each channel one by one and adjust Lx2 in the corresponding oscillator for maximum voltmeter reading.

Connect the voltmeter to RX CM 1 and 6, and fine tune L1, L2 and L3 on the center frequency to maximum reading on voltmeter

SYNTHESIZER VERSION FG932

Connect voltmeter to RX CM 1 and 10.

Adjust L1 (FG932) for maximum reading on the voltmeter and then L2 for minimum reading.

Connect voltmeter to RX CM 1 and 8 and fine tune L_{X3}, L1 and L2 for maximum voltmeter reading.

Preadjust cores in L3 to L11 to 1 mm higher than cores in L1 and L2.

Connect voltmeter to RX CM 1 and 6.

Adjust L3, L4, L5, L6, L7, L8 and L9 for maximum voltmeter reading.

Detune L5 until reading 100 mV on the voltmeter and adjust L3, L4 and L6 for maximum voltmeter reading.

Adjust L5 for maximum reading.

Detune L8 until the reading on the voltmeter is 100 mV and adjust L7 and L9 for maximum voltmeter reading.

Adjust L8 for maximum reading.

Connect voltmeter to RX CM 1 and 5.

Adjust L10 and L11 in FG932, L3, L4, L1 in RC931 for maximum voltmeter reading.

RC931

Connect the voltmeter to RX CM 1 and 5.

Adjust L4, L3 and L1 in RC931 for maximum voltmeter reading.



RECEIVER FREQUENCY FINE TUNING

MULTIPLIER VERSION FG933

Connect a frequency counter to the output of FG933, output level approx. 13 dBm.

Calculate the injection frequency:

$$F_{inj} = F_{ant} - 21.4 \text{ MHz}$$

Select each channel one by one and measure the frequency.

If the frequency is not correct adjust L_{X1} in the corresponding oscillator for correct frequency.

SYNTHESIZER VERSION FG932

Before adjustment of the injection frequency the synthesizer frequency should be checked, refer to Frequency Synthesizer Adjustment.

Connect a frequency counter to the output of FG932, J2, output level approx. +13 dBm.

Calculate the injection frequency:

$$F_{inj} = F_{ant} - 21.4 \text{ MHz}$$

Adjust L_{X2} (L2 in XO932) for correct injection frequency according to the temperature curve.

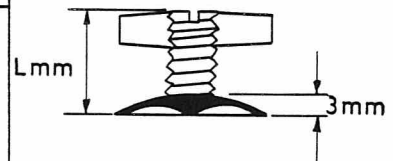
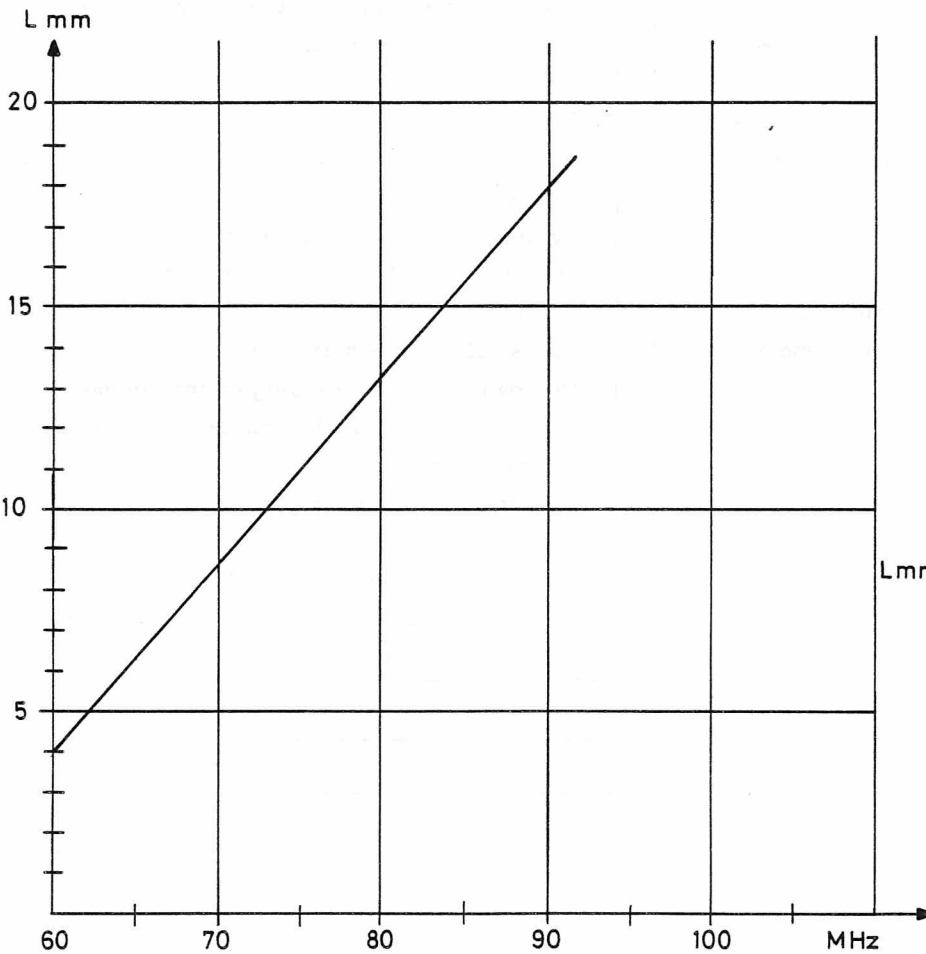

TUNING SLUGS RC931

D403.231

RECEIVER FRONT-END ALIGNMENT

SIMPLEX + DUPLEX RC931

This adjustment is only necessary if the helixfilters are out of adjustment or need readjustment.

Connect the signal generator to the antenna connector and set its frequency to the channel frequency.

Set the signal generator output level to 100 dB/1 uV or 100 mV.

Preadjust the tuning slugs TS1-TS2-TS3-TS4-TS5 to their approximate positions according to the graph on page 2.

Connect the voltmeter to RX CM 1 and 4.

Adjust TS1-TS2-TS3-TS4, L1 and L2 for maximum voltmeter reading.

Decrease the signal generator level to be below the limiting point of the IF-amplifier as the sensitivity increases and before fine tuning.

Adjust TS5 to approximately the same height as TS4.

Detune TS2 and TS4 about 4 turns (~3 mm).

Adjust TS1, TS3, TS5 and L1 in RC931 for maximum voltmeter reading.

Adjust TS2 and TS4 for maximum voltmeter reading. Repeat the adjustment until no further improvement is possible.

Fine tune TS1, TS2, TS3, TS4, TS5, L1 and L2 for maximum voltmeter reading.

DUPLEX FILTER BF931

The duplex filter is factory adjusted to the ordered channel frequencies and need not be readjusted.



↓

IF FINE TUNING AND AUDIO POWER SETTING

IF AMPLIFIER ADJUSTMENT IA90x

Connect the signal generator to the antenna connector.
Set the generator frequency to the channel frequency and its output level to 1 mV EMF. Modulate the signal generator with 1 kHz to:

- 3.0 kHz for 25 kHz channel spacing
- 1.5 kHz for 12.5 kHz channel spacing
- 2.5 kHz for 20 kHz channel spacing

Connect the voltmeter to RX CM 1 and 4 and adjust L1, L2 and L3 to maximum reading. Connect a distortionmeter to the RX output multiconnector A-E, and adjust L1, L4 for minimum distortion.

SIMPLEX + DUPLEX RC931

Adjust L2 in RC931 for minimum distortion.
Connect the voltmeter to RX CM 1 and 4.
Check the voltmeter reading for being approximately 0.5 V for 10 μ V input signal (EMF).

AUDIO LINE LEVEL SETTING AA9018

Connect an AF voltmeter and a 600 ohm resistor to the RX output multiconnector A-E.
Set the output level from the signal generator to 1 mV EMF on the channel frequency. Modulate the signal generator with 1 kHz to:

- 3.0 kHz for 25 kHz channel spacing
- 1.5 kHz for 12.5 kHz channel spacing
- 2.5 kHz for 20 kHz channel spacing

Adjust the potentiometer R8 in AA9018 for a reading of 1.1 V RMS.

↓

↓
CHECKING RECEIVER SENSITIVITY

Select the center channel.
Set the signal generator to the receiver frequency and adjust the output level to 1 mV EMF.
Connect a distortion meter with a psophometric filter and a 600 ohm resistor to the RX output multiconnector A-E.
Measure the receiver sensitivity according to CEPT specifications (or EIA).

SIMPLEX RC931

CEPT SENSITIVITY SPECIFICATION, SIMPLEX

RC931:
20 dB psophometric SINAD for V_{input} less than:
0.7 μ V EMF

EIA SENSITIVITY SPECIFICATION

RC931:
12 dB SINAD for V_{input} less than:
0.35 μ V ($\frac{1}{2}$ EMF)

DUPLEX RC931 + BF931

CEPT SENSITIVITY SPECIFICATION

With RC931 and BF931:
20 dB psophometric SINAD for
 V_{input} less than 0.95 μ V EMF.

EIA SENSITIVITY SPECIFICATION

With RC931 and BF931:
12 dB SINAD for
 V_{input} less than 0.45 μ V ($\frac{1}{2}$ EMF).

Measure the sensitivity on the highest and lowest channel frequencies.
Compared with the measured sensitivity on the center channel the sensitivity degradation shall be less than 1 dB.



SQUELCH ADJUSTMENT

Connect the signal generator to the antenna connector and set it to the receiver frequency. Modulate the signal generator with 1 kHz to:

3.0 kHz for 25 kHz channel spacing

1.5 kHz for 12.5 kHz channel spacing

2.5 kHz for 20 kHz channel spacing

Set the signal generator output level to the measured SINAD sensitivity.

Reduce the signal generator output 2 dB.

Adjust R_{SQ} (R4 on AA9018) until the squelch circuit just opens the receiver AF output.

Check that the squelch closes when the RF signal is removed from the antenna input.

CHECKING RECEIVER CURRENT CONSUMPTION
(12 V DC ONLY)

Measure the receiver current drain at $V_{BATT} = 13.6$ V.

Off condition: less than 75 mA

Standby: less than 1 A

TRANSMITTER ADJUSTMENT

CQF9330

Connect a VHF power meter, 25 W (40 W), to the antenna connector.
Select the center channel. Key the transmitter when adjusting.

EXCITER ALIGNMENT

MULTIPLIER VERSION EX932

Connect the voltmeter to TX CM 1 and 10.
Preset L1, L2, L9, L10 in EX932 to the approximate position, see the graph.
Detune L2 as much as possible.
Adjust L1 for maximum voltmeter reading.
Connect the voltmeter to TX CM 1 and 6.
Adjust L2 for maximum voltmeter reading.
Adjust Lx2 (output) in the corresponding oscillator XO933 for maximum voltmeter reading.
Repeat the adjustment of L1 and L2 for maximum until no further improvement is possible.

For multichannel radios select, one by one, all channels and adjust Lx2 in the oscillator corresponding to the selected channel for maximum voltmeter reading.

Connect the voltmeter to PA CM connector 1 and 10.
Adjust L9 and L10 in EX932 for maximum voltmeter reading.
Repeat the adjustment of L9 and L10 until no further improvement is possible.

SYNTHESIZER VERSION EX911

Connect the voltmeter to TX CM 1 and 10.
In EX931 adjust L12 for maximum voltmeter reading, L13 for minimum reading.
Minimum voltage reading should be at least 0.1 V.
Connect the voltmeter to TX CM 1 and 9.
In EX931 adjust L3 (XO), L12 and L13 for maximum voltmeter reading.
Repeat the adjustment until no further improvement is possible.

Preset the tuning slugs of L3, L4, L5, L7, L8, L9, L10 and L11 (EX931) to approximately the same position as L12 and L13. This ensures selection of the correct mixer output frequency.

Connect the voltmeter to TX CM 1 and 5.
Adjust L3, L4, L5 and L7 for maximum voltmeter reading.
Connect the voltmeter to TX CM 1 and 6.
Adjust L7 and L8 for maximum voltmeter reading.
If the output level is not high enough to give a meter deflection, connect the voltmeter to the PA CM connector 1-10.

Connect the voltmeter to PA CM 1 and 10.
Adjust L10, and L11 for maximum voltmeter reading. The reading should be at least 0.3 V.

FREQUENCY ADJUSTMENT

SYNTHESIZER VERSION EX931

Before adjusting the transmitter frequency the synthesizer frequency should be checked, refer to Frequency Synthesizer Adjustment.

Connect the frequency counter to the output of EX931 (J2) through an attenuator (output level 0.5 W).

Key the transmitter.

Measure the frequency and if necessary adjust with Lx2 in EX931.

Requirement: $F_{ant} \pm 100$ Hz

The frequency setting is temperature dependent according to the following graph.

Note:

The transmitter shall be unmodulated when adjusting the frequency.

MULTIPLIER VERSION EX932

Connect the frequency counter to the output of EX932 (J2) through an attenuator (output level 0.5 W).

Select the channels one by one and measure the frequency.

Key the transmitter. The channel cannot be changed while keying the transmitter. If necessary adjust the frequency with Lx1 in the corresponding oscillator.

Requirement: $F_{ant} \pm 100$ Hz

The frequency setting is temperature dependent according to the following graph.

Note:

The transmitter shall be unmodulated when adjusting the frequency.

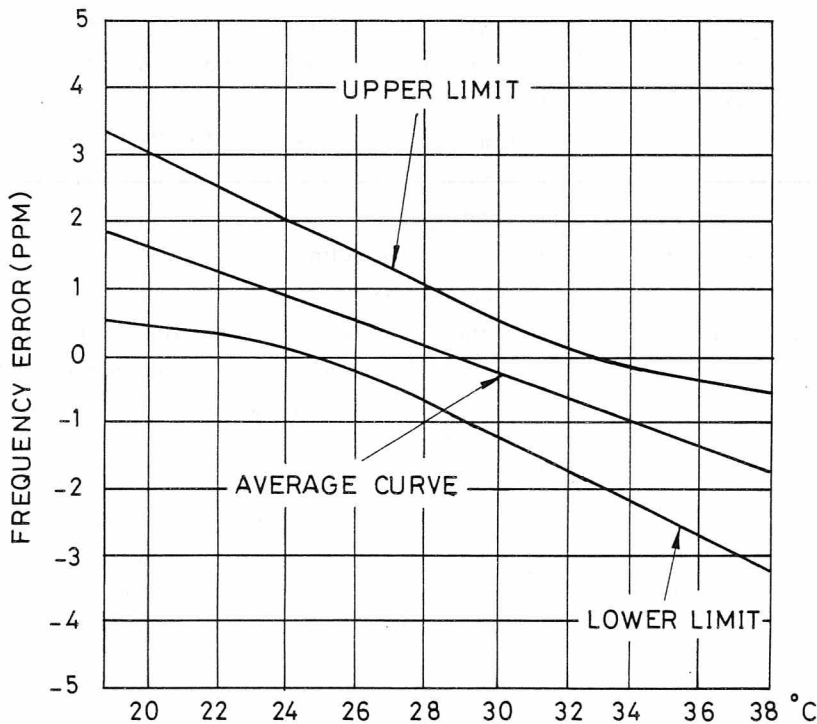

XO900 FREQUENCY ERROR CURVE

D403.172

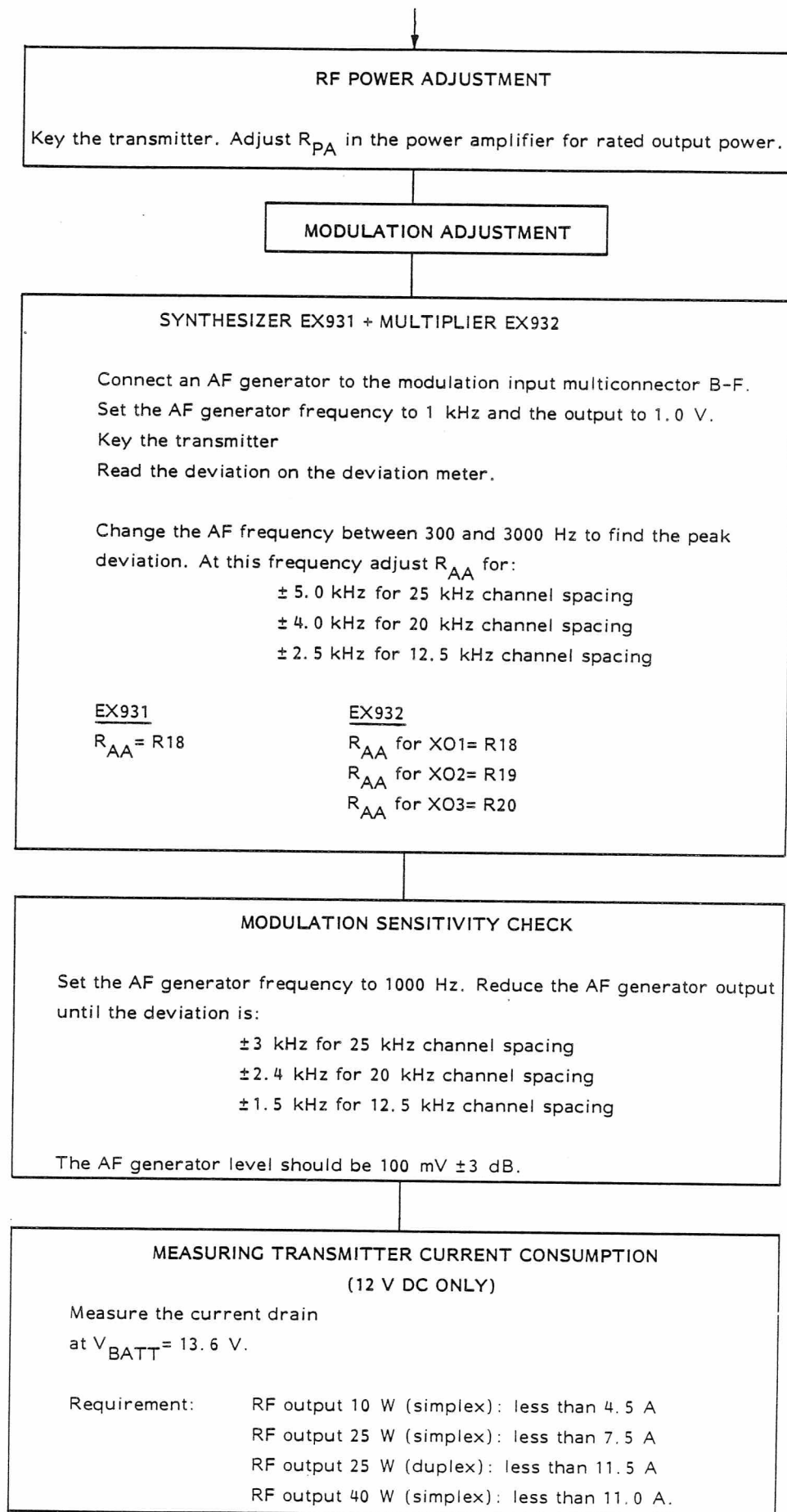

RECEIVER ADJUSTMENT

CQF9550

RECEIVER INJECTION SIGNAL ALIGNMENT

SIMPLEX/DUPLEX PL951

Connect the voltmeter to RX CM 1 and 10.

Tune L_{XO} and L12 in the PL951 for max. meter reading (1.5 V).

Connect the voltmeter to RX CM 1 and 9.

Tune L13 and then L12 to max. meter reading.

Retune L_{XO} , L12 and L13 to max; app. 0.7-1.0 V.

Connect the voltmeter to RX CM 1 and 8.

Detune L14 and L15. Now tune L14 for max. meter reading, and after this, tune L15 to min. (1.0 V).

CAUTION! The max. and min. shall be well defined and easy to find.
Do not retune L14.

Select a center channel on the control head.

Connect the voltmeter to RX CM 1 and 6.

Fine tune C1 to 0.6 V.

RC953

Preset L4 and L5 in RC953 according to the following graph, A.

Connect the voltmeter to RX CM 1 and 5.

Adjust L4, L5 and C2 in RC953 for maximum voltmeter reading.

RECEIVER FREQUENCY FINE TUNING

SIMPLEX/DUPLEX PL951

Check synthesizer frequency before adjustment.

Connect a frequency counter to RX output of PL951, J2.

Output level approx. 13 dBm.

Calculate the injection frequency:

$$F_{inj} = F_{ant} - 21.4 \text{ MHz}$$

Adjust L2 (XO1) in PL951 for correct injection frequency according to the temperature curve.

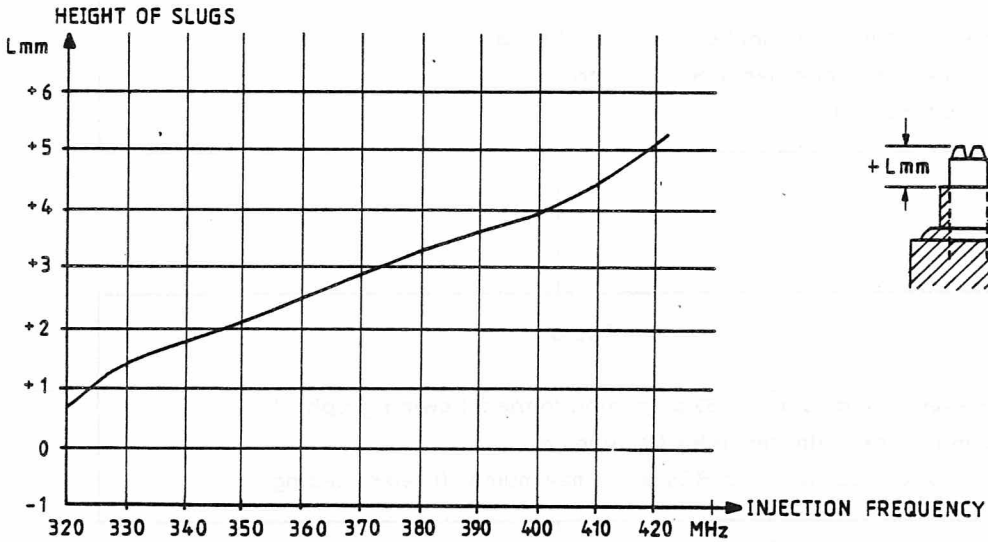

TUNING SLUGS RC953

D403.524

RECEIVER FRONT-END ALIGNMENT

SIMPLEX RC953 AND DUPLEX RC953 + BF951

This adjustment is only necessary if the helix filters are out of adjustment or need readjustment.

Connect the signal generator to the antenna connector and set its frequency to the channel frequency.

Set the signal generator output level to 100 mV.

Preadjust the tuning slugs TS1-TS2-TS3-TS4-TS5 to their approximate positions according to the graph page 2.

Connect the voltmeter to RX CM 1 and 4.

Adjust TS1-TS2-TS3-TS4, C2 and L2 for maximum voltmeter reading.

Decrease the signal generator level to be below the limiting point of the IF-amplifier as the sensitivity increases and before fine tuning.

Adjust TS5 to approximately the same height as TS4.

Detune TS2 and TS4 about 4 turns (~3 mm).

Adjust TS1, TS3, TS5 and C2 in RC953 for maximum voltmeter reading.

Adjust TS2 and TS4 for maximum voltmeter reading. Repeat the adjustment until no further improvement is possible.

Fine tune TS1, TS2, TS3, TS4, TS5, C2 and L2 for maximum voltmeter reading.

DUPLEX FILTER BF951

The duplex filter is factory adjusted to the ordered channel frequencies and need not be readjusted.



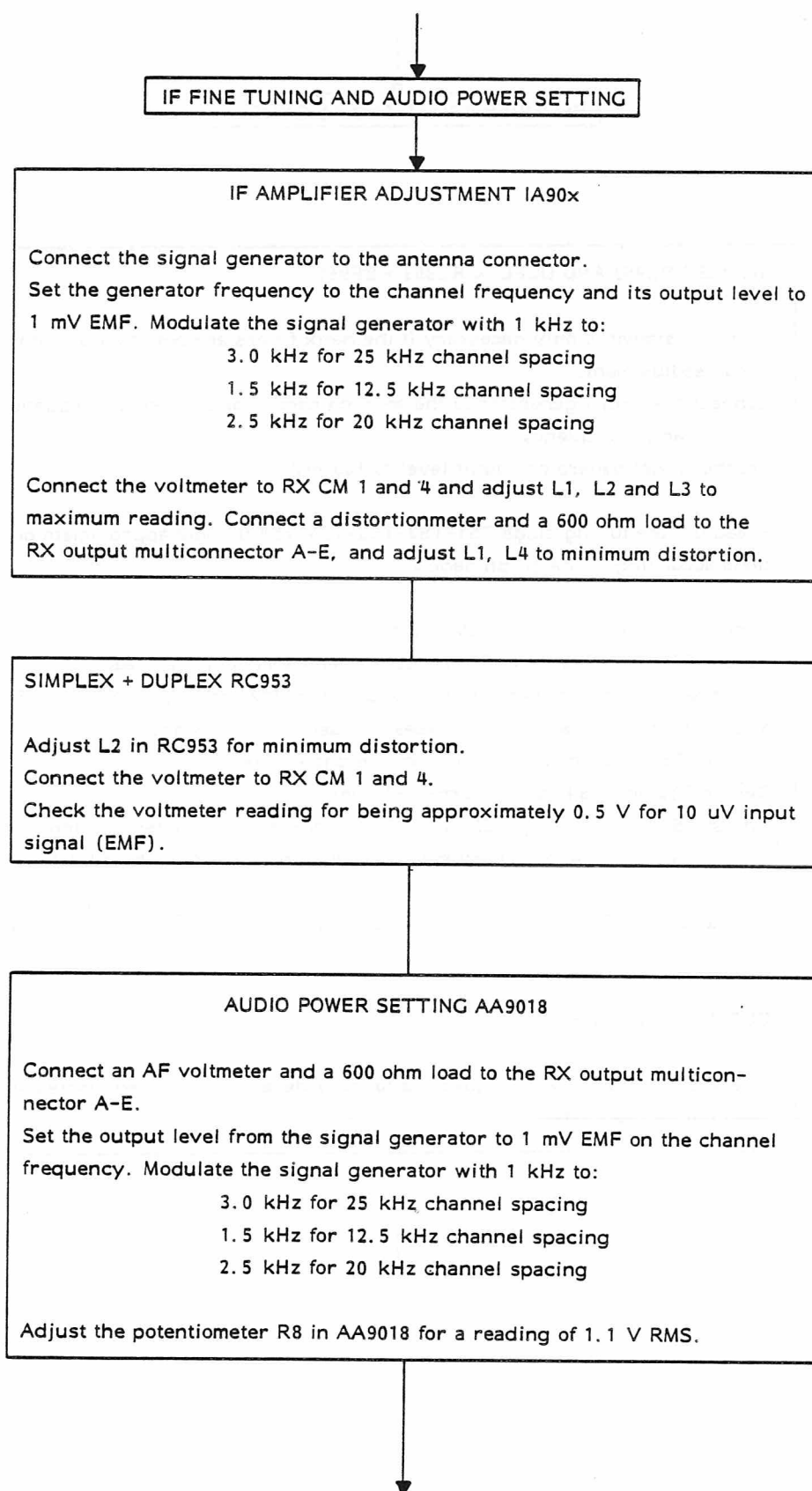

↓

CHECKING RECEIVER SENSITIVITY

Select the center channel.
 Set the signal generator to the receiver frequency and adjust the output level to 1 mV EMF.
 Connect a distortion meter with a psophometric filter and a 600 ohm resistor to the RX output multiconnector A-E.
 Measure the receiver sensitivity according to CEPT specifications (or EIA).

SIMPLEX RC953

CEPT SENSITIVITY SPECIFICATION

RC953:
 20 dB psophometric SINAD
 for V_{input} less than:
 0.7 μ V EMF

EIA SENSITIVITY SPECIFICATION

RC953:
 12 dB SINAD
 for V_{input} less than:
 0.35 μ V ($\frac{1}{2}$ EMF)

DUPLEX RC953 + BF951

CEPT SENSITIVITY SPECIFICATION

With RC953 and BF951:
 20 dB psophometric SINAD for
 V_{input} less than 0.9 μ V EMF.

EIA SENSITIVITY SPECIFICATION

With RC953 and BF951:
 12 dB SINAD for
 V_{input} less than 0.45 μ V ($\frac{1}{2}$ EMF).

Measure the sensitivity on the highest and lowest channel frequencies.

Compared with the measured sensitivity on the center channel the sensitivity degradation shall be less than 1 dB.

↓

SQUELCH ADJUSTMENT

Connect the signal generator to the antenna connector and set it to the receiver frequency. Modulate the signal generator with 1 kHz to:

- 3.0 kHz for 25 kHz channel spacing
- 1.5 kHz for 12.5 kHz channel spacing
- 2.5 kHz for 20 kHz channel spacing

Set the signal generator output level to the measured SINAD sensitivity.

Reduce the signal generator output 2 dB.

Adjust R_{SQ} (R4 on AA9018) until the squelch circuit just opens the receiver AF output.

Check that the squelch closes when the RF signal is removed from the antenna input.

CHECKING RECEIVER CURRENT CONSUMPTION
(12 V DC only)

Measure the receiver current drain at $V_{BATT} = 13.6$ V.

- Off condition: less than 75 mA
- Standby: less than 1 A

TRANSMITTER ADJUSTMENT

CQF9550

Connect a UHF power meter, 25 W (40 W, 100 W), to the antenna connector. Set the power supply voltage to 13.6 V. Set the current limiter to 10 A. Select the center channel. Key the transmitter when adjusting.

EXCITER ALIGNMENT

SIMPLEX/DUPLEX PL952

Connect the voltmeter to TX CM 1 and 10.

Tune L_{XO} and L16 in the PL952 for max. meter reading (0.9 V).

Connect the voltmeter to TX CM 1 and 9.

Tune L_{XO} L16 and L15 for max. meter reading (0.9 V).

Connect the voltmeter to TX CM 1 and 8.

Detune L_{11} and L12. Now tune L12 for max. meter reading, and after this tune L11 to min. (2.8 V).

Caution! The max. and min. shall be well defined and easy to find. Do not retune L12.

Connect the voltmeter to TX CM 1 and 5.

Tune C2 slowly until the meter reading goes high (0.7 V).

Connect the voltmeter to 1 and 6. Fine tune C2 to 0.6 V.



↓
FREQUENCY ADJUSTMENT
 ↓

SIMPLEX/DUPLEX PL952

Before adjusting the transmitter frequency the synthesizer frequency should be checked, refer to Frequency Synthesizer Adjustment.

Connect the frequency counter to the output of PL952 (J1) through an attenuator (output level 0.5 W).

Key the transmitter.

Measure the frequency and if necessary adjust the frequency with Lx (FREQ.).

Requirement: $F_{ant} \pm 350 \text{ Hz}$

The frequency setting is temperature dependent according to the graph.

Note: The transmitter shall be unmodulated when adjusting the frequency.

↓

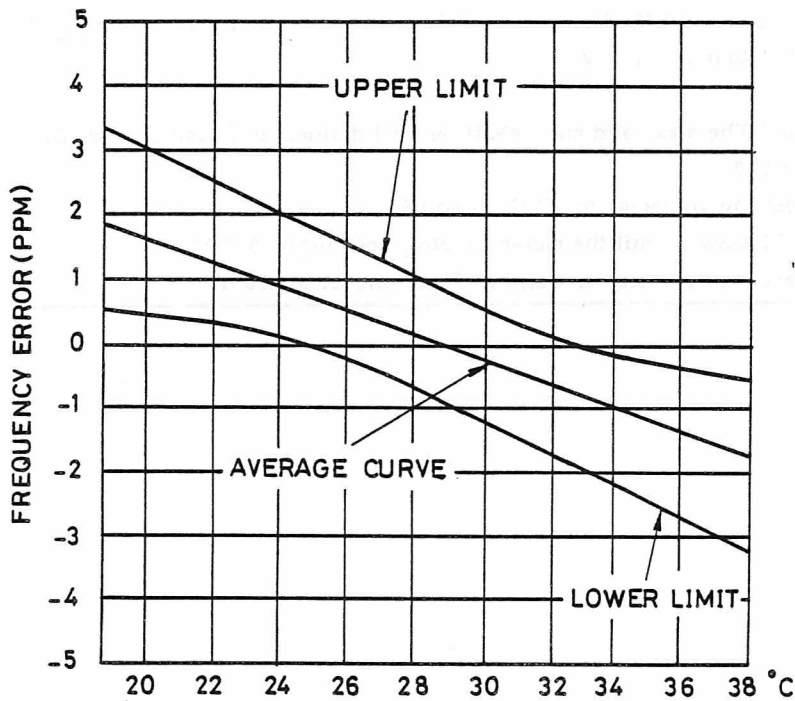

X0900 FREQUENCY ERROR CURVE

D403.172

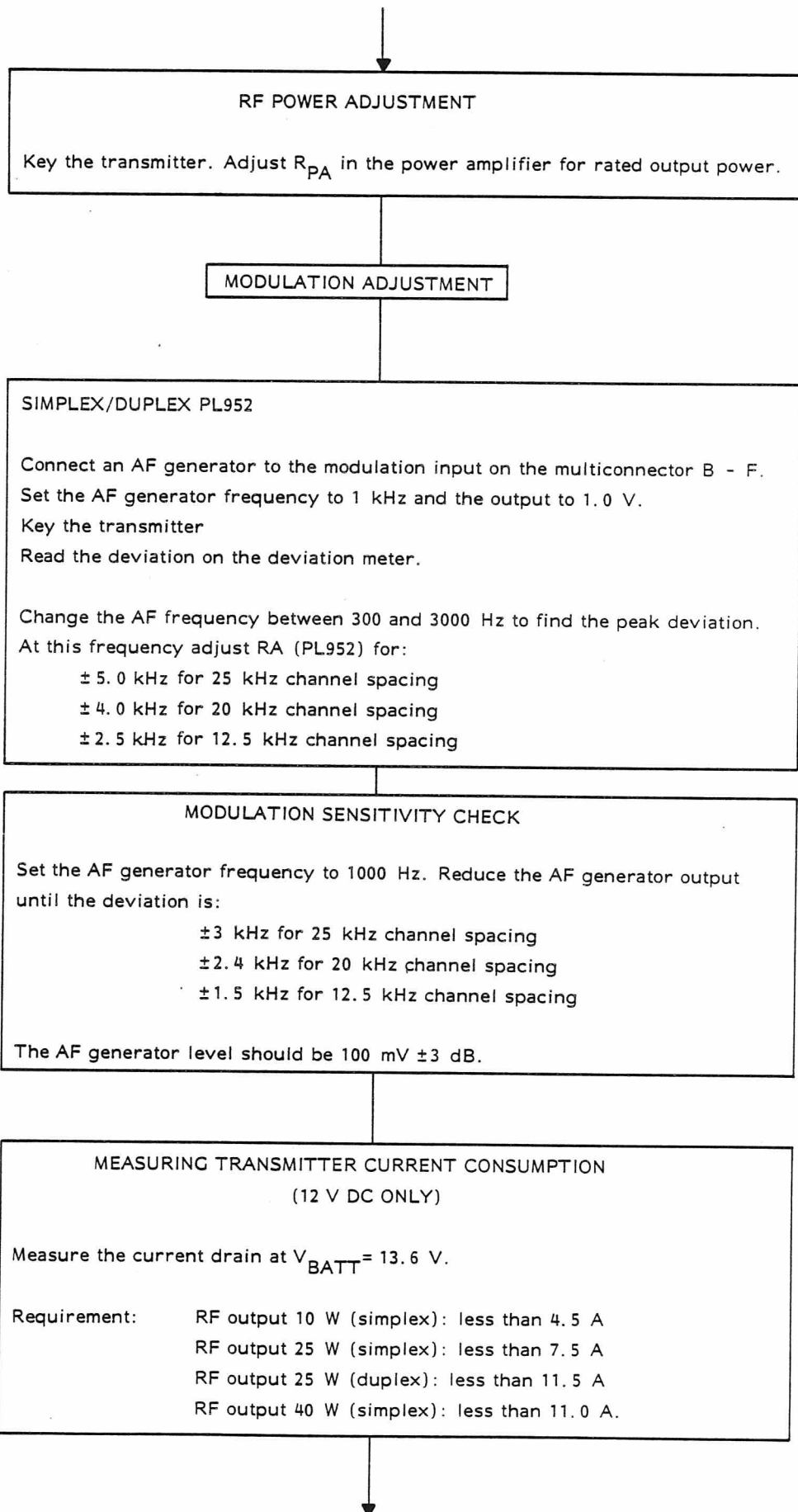

RECEIVER ADJUSTMENT

CQF9660

RECEIVER INJECTION SIGNAL ALIGNMENT

SIMPLEX/DUPLEX PL961

Connect the voltmeter to RX CM 1 and 10.
Tune L_{XO} and L12 in the PL961 for max. meter reading (1.5 V).
Connect the voltmeter to RX CM 1 and 9.
Tune L13 and then L12 to max. meter reading.
Retune L_{XO} , L12 and L13 to max; app. 0.7-1.0 V.
Connect the voltmeter to RX CM 1 and 8.
Detune L14 and L15. Now tune L14 for max. meter reading, and after this, tune L15 to min. (1.0 V).

CAUTION! The max. and min. shall be well defined and easy to find.
Do not retune L14.

Select a center channel on the control head.
Connect the voltmeter to RX CM 1 and 6.
Fine tune C1 to 0.6 V.

MULTIPLIER FG961

Connect voltmeter to RX CM 1 and 10.
Adjust L_{XO} and L1 in FG961 for maximum reading.
Connect the voltmeter to RX CM 1 and 6.
Adjust L1 and L3 for maximum reading.
The deflection can be negative in which case the voltmeter connections are reversed.
Repeat the adjustment of L1 and L3.
The voltmeter reading should be 0.3-0.8 V.
Preset L8 and L9 in FG961 and L4 and L5 in RC969/RC962 according to the following graph.

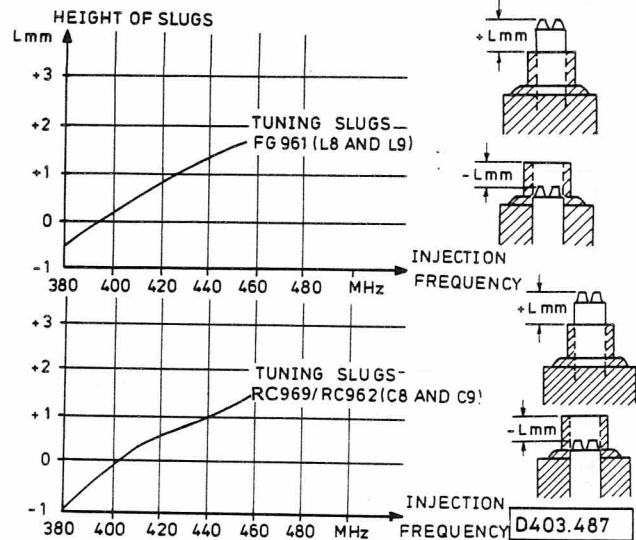

Connect the voltmeter to RX CM 1 and 5.
Adjust C21, L8 and L9 in FG961 for maximum voltmeter reading, approximately 0.5 V.
Repeat the adjustment until no further improvement is possible.

RC969/RC962

Connect the voltmeter to RX CM 1 and 5.
Adjust L4, L5 and C2 in RC969/RC962 for maximum voltmeter reading.

RECEIVER ADJUSTMENT, CQF9660

RECEIVER FREQUENCY FINE TUNING

SIMPLEX/DUPLEX PL961

Check synthesizer frequency before adjustment.
Connect a frequency counter to RX output of PL961, J2.

Output level approx. 13 dBm.

Calculate the injection frequency:

$$F_{inj} = F_{ant} - 21.4 \text{ MHz}$$

Adjust L2 (XO1) in PL961 for correct injection frequency according to the temperature curve.

MULTIPLIER FG961

Connect a frequency counter to the output of FG961, output level approx. 13 dBm.

Calculate the injection frequency:

$$F_{inj} = F_{ant} - 21.4 \text{ MHz}$$

Select each channel one by one and measure the frequency.

If the frequency is not correct adjust L_{X1} in the corresponding oscillator for correct frequency.

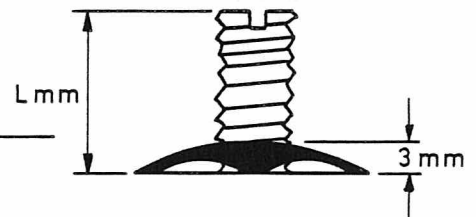
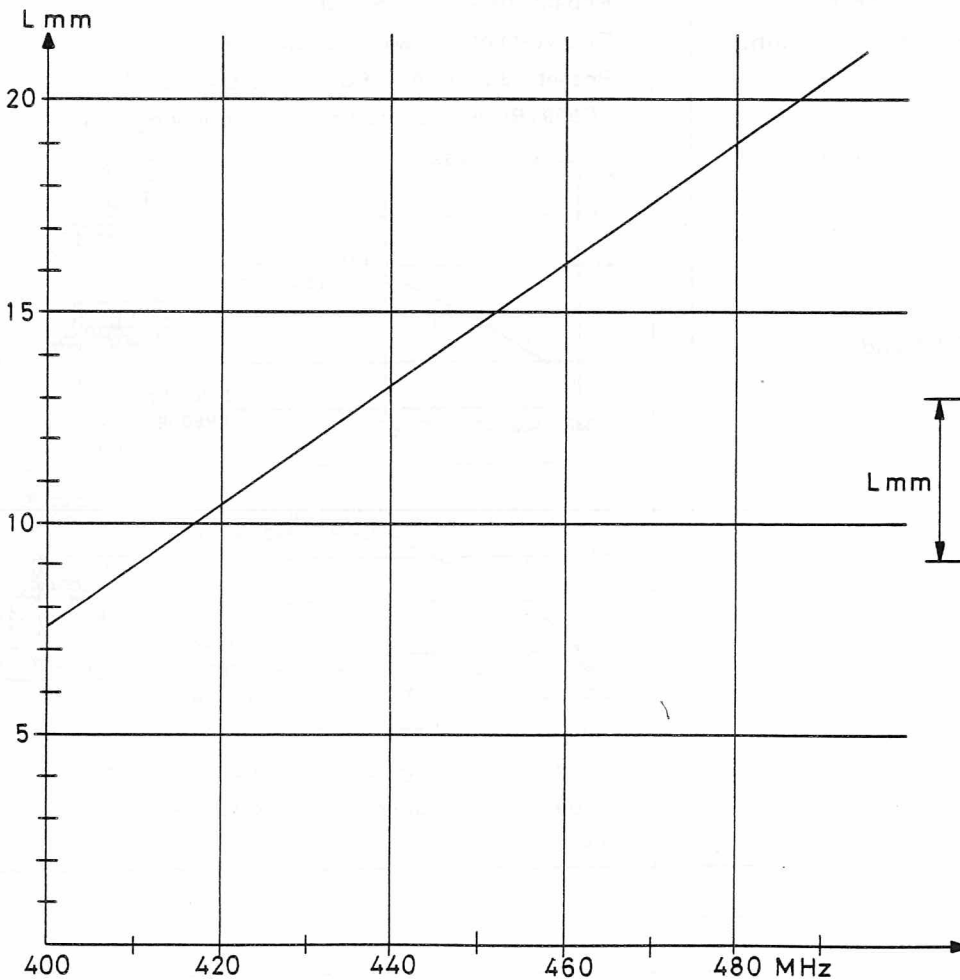

TUNING SLUGS RC969

D403.240/2

RECEIVER ADJUSTMENT, CQF9660



RECEIVER FRONT-END ALIGNMENT

SIMPLEX RC969/RC962 AND DUPLEX RC969 + BF961

This adjustment is only necessary if the helix filters are out of adjustment or need readjustment.

Connect the signal generator to the antenna connector and set its frequency to the channel frequency.

Set the signal generator output level to 100 mV.

Preadjust the tuning slugs TS1-TS2-TS3-TS4-TS5 to their approximate positions according to the graph page 2.

Connect the voltmeter to RX CM 1 and 4.

Adjust TS1-TS2-TS3-TS4, C2 and L2 for maximum voltmeter reading.

Decrease the signal generator level to be below the limiting point of the IF-amplifier as the sensitivity increases and before fine tuning.

Adjust TS5 to approximately the same height as TS4.

Detune TS2 and TS4 about 4 turns (~3 mm).

Adjust TS1, TS3, TS5 and C2 in RC969/RC962 for maximum voltmeter reading.

Adjust TS2 and TS4 for maximum voltmeter reading. Repeat the adjustment until no further improvement is possible.

Fine tune TS1, TS2, TS3, TS4, TS5, C2 and L2 for maximum voltmeter reading.

DUPLEX FILTER BF961

The duplex filter is factory adjusted to the ordered channel frequencies and need not be readjusted.



RECEIVER ADJUSTMENT, CQF9660

IF FINE TUNING AND AUDIO POWER SETTING

IF AMPLIFIER ADJUSTMENT IA90x

Connect the signal generator to the antenna connector.
Set the generator frequency to the channel frequency and its output level to 1 mV EMF. Modulate the signal generator with 1 kHz to:

- 3.0 kHz for 25 kHz channel spacing
- 1.5 kHz for 12.5 kHz channel spacing
- 2.5 kHz for 20 kHz channel spacing

Connect the voltmeter to RX CM 1 and 4 and adjust L1, L2 and L3 to maximum reading. Connect a distortionmeter and a 600 ohm load to the RX output multiconnector A-E, and adjust L1, L4 to minimum distortion.

SIMPLEX RC962

Adjust L2 in RC962 for minimum distortion.
Connect the voltmeter to RX CM 1 and 4.
Check the voltmeter reading for being approximately 0.5 V for 3 μ V.

SIMPLEX + DUPLEX RC969

Adjust L2 in RC969 for minimum distortion.
Connect the voltmeter to RX CM 1 and 4.
Check the voltmeter reading for being approximately 0.5 V for 10 μ V input signal (EMF).

AUDIO POWER SETTING AA9018

Connect an AF voltmeter and a 600 ohm load to the RX output multiconnector A-E.
Set the output level from the signal generator to 1 mV EMF on the channel frequency. Modulate the signal generator with 1 kHz to:

- 3.0 kHz for 25 kHz channel spacing
- 1.5 kHz for 12.5 kHz channel spacing
- 2.5 kHz for 20 kHz channel spacing

Adjust the potentiometer R8 in AA9018 for a reading of 1.1 V RMS.

RECEIVER ADJUSTMENT, CQF9660

CHECKING RECEIVER SENSITIVITY

Select the center channel.
Set the signal generator to the receiver frequency and adjust the output level to 1 mV EMF.
Connect a distortion meter with a psophometric filter and a 600 ohm resistor to the RX output multiconnector A-E.
Measure the receiver sensitivity according to CEPT specifications (or EIA).

SIMPLEX RC969 OR RC962

CEPT SENSITIVITY SPECIFICATION

RC969

20 dB psophometric SINAD

for V_{input} less than:

0.7 μ V EMF

RC962:

0.4 μ V EMF

EIA SENSITIVITY SPECIFICATION

RC969:

12 dB SINAD

for V_{input} less than:

0.35 μ V ($\frac{1}{2}$ EMF)

RC962

0.2 μ V ($\frac{1}{2}$ EMF)

In radios with RC962 the sensitivity can be optimized by fine tuning TS2 for maximum SINAD.

DUPLEX RC969 + BF961

CEPT SENSITIVITY SPECIFICATION

With RC969 and BF961:

20 dB psophometric SINAD for

V_{input} less than 0.9 μ V EMF.

EIA SENSITIVITY SPECIFICATION

With RC969 and BF961:

12 dB SINAD for

V_{input} less than 0.45 μ V ($\frac{1}{2}$ EMF).

Measure the sensitivity on the highest and lowest channel frequencies.

Compared with the measured sensitivity on the center channel the sensitivity degradation shall be less than 1 dB.

↓

SQUELCH ADJUSTMENT

Connect the signal generator to the antenna connector and set it to the receiver frequency. Modulate the signal generator with 1 kHz to:

- 3.0 kHz for 25 kHz channel spacing
- 1.5 kHz for 12.5 kHz channel spacing
- 2.5 kHz for 20 kHz channel spacing

Set the signal generator output level to the measured SINAD sensitivity.

Reduce the signal generator output 2 dB.

Adjust R_{SQ} (R4 on AA9018) until the squelch circuit just opens the receiver AF output.

Check that the squelch closes when the RF signal is removed from the antenna input.

CHECKING RECEIVER CURRENT CONSUMPTION (12 V DC ONLY)

Measure the receiver current drain at $V_{BATT} = 13.6 \text{ V}$.

Off condition:	less than 75 mA
Standby:	less than 1 A

TRANSMITTER ADJUSTMENT

CQF9660

Connect a UHF power meter, 25 W (40 W, 100 W), to the antenna connector.
 Set the power supply voltage to 13.6 V. Set the current limiter to 10 A.
 Select the center channel. Key the transmitter when adjusting.

EXCITER ALIGNMENT

SIMPLEX/DUPLEX PL962

Connect the voltmeter to TX CM 1 and 10.
 Tune L_{X0} and L16 in the PL962 for max. meter reading (0.9 V).
 Connect the voltmeter to TX CM 1 and 9.
 Tune L_{X0} L16 and L15 for max. meter reading (0.9 V).
 Connect the voltmeter to TX CM 1 and 8.
 Detune L11 and L12. Now tune L12 for max. meter reading, and after this tune L11 to min. (2.8 V).

 Caution! The max. and min. shall be well defined and easy to find. Do not retune L12.
 Connect the voltmeter to TX CM 1 and 5.
 Tune C2 slowly until the meter reading goes high (0.7 V).
 Connect the voltmeter to 1 and 6. Fine tune C2 to 0.6 V.

MULTIPLIER EX961

Connect the voltmeter to TX CM 1 and 10.
 Adjust L_{X0} and L1 in EX961 for maximum voltmeter reading.
 Connect the voltmeter to TX CM 1 and 6.
 Adjust L1 and L3 for maximum voltmeter reading. Repeat the adjustment twice.
 Adjust C35 and C23 for maximum voltmeter reading. The deflection can be negative in which case the voltmeter connections are reversed. The voltmeter reading should be 0.3 - 0.8 V.

 Connect the voltmeter to PA CM connector 1 and 10.
 Preset the slugs of L11 and L12 on EX961.

 Adjust C35, C23, L11 and L12 for maximum voltmeter reading.

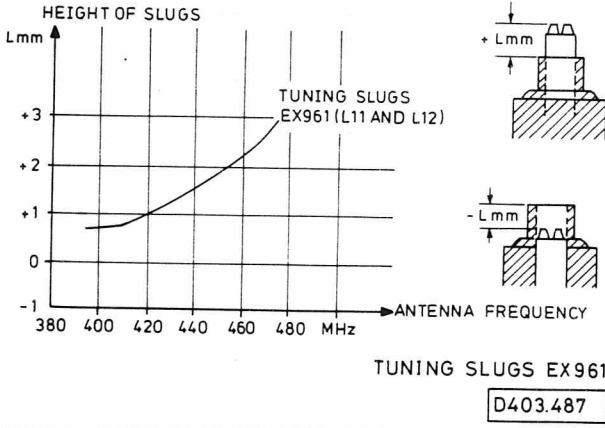

FREQUENCY ADJUSTMENT

SIMPLEX/DUPLEX PL962

Before adjusting the transmitter frequency the synthesizer frequency should be checked, refer to Frequency Synthesizer Adjustment.

Connect the frequency counter to the output of PL962 (J1) through an attenuator (output level 0.5 W).

Key the transmitter.

Measure the frequency and if necessary adjust the frequency with Lx (FREQ.).

Requirement: $F_{ant} \pm 450 \text{ Hz}$

The frequency setting is temperature dependent according to the graph.

Note: The transmitter shall be unmodulated when adjusting the frequency.

MULTIPLIER EX961

Connect the frequency counter to the output of EX961 (J1) through an attenuator (output level 0.5 W).

Select the channels one by one and measure the frequency.

Key the transmitter. The channel cannot be changed while keying the transmitter. If necessary adjust the frequency with Lx1 in the corresponding oscillator.

Requirement: $F_{ant} \pm 450 \text{ Hz}$

The frequency setting is temperature dependent according to the following graph (fig 3).

Note: The transmitter shall be unmodulated when adjusting the frequency.

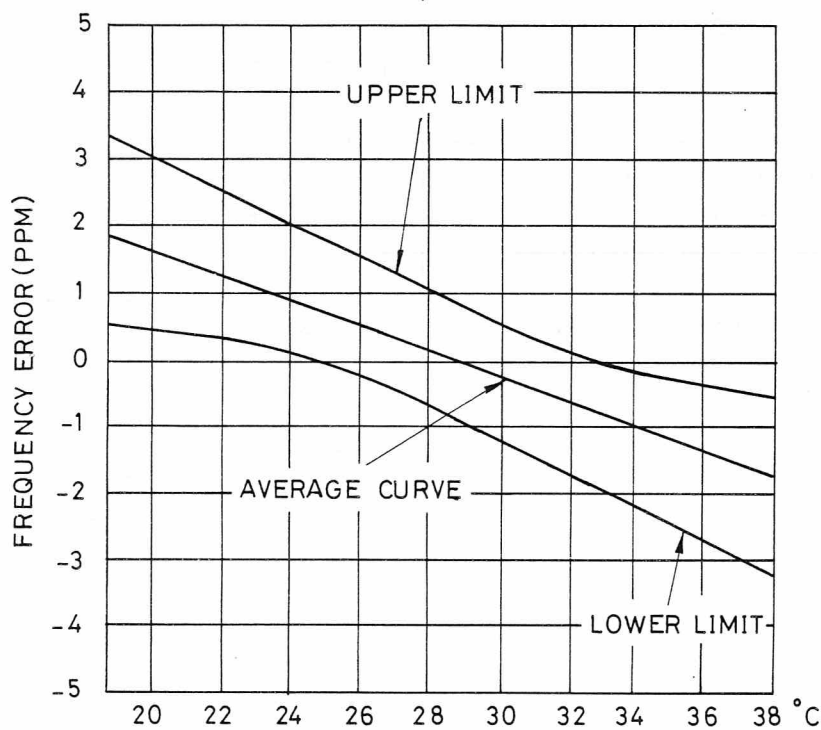

XO900 FREQUENCY ERROR CURVE

D403.172

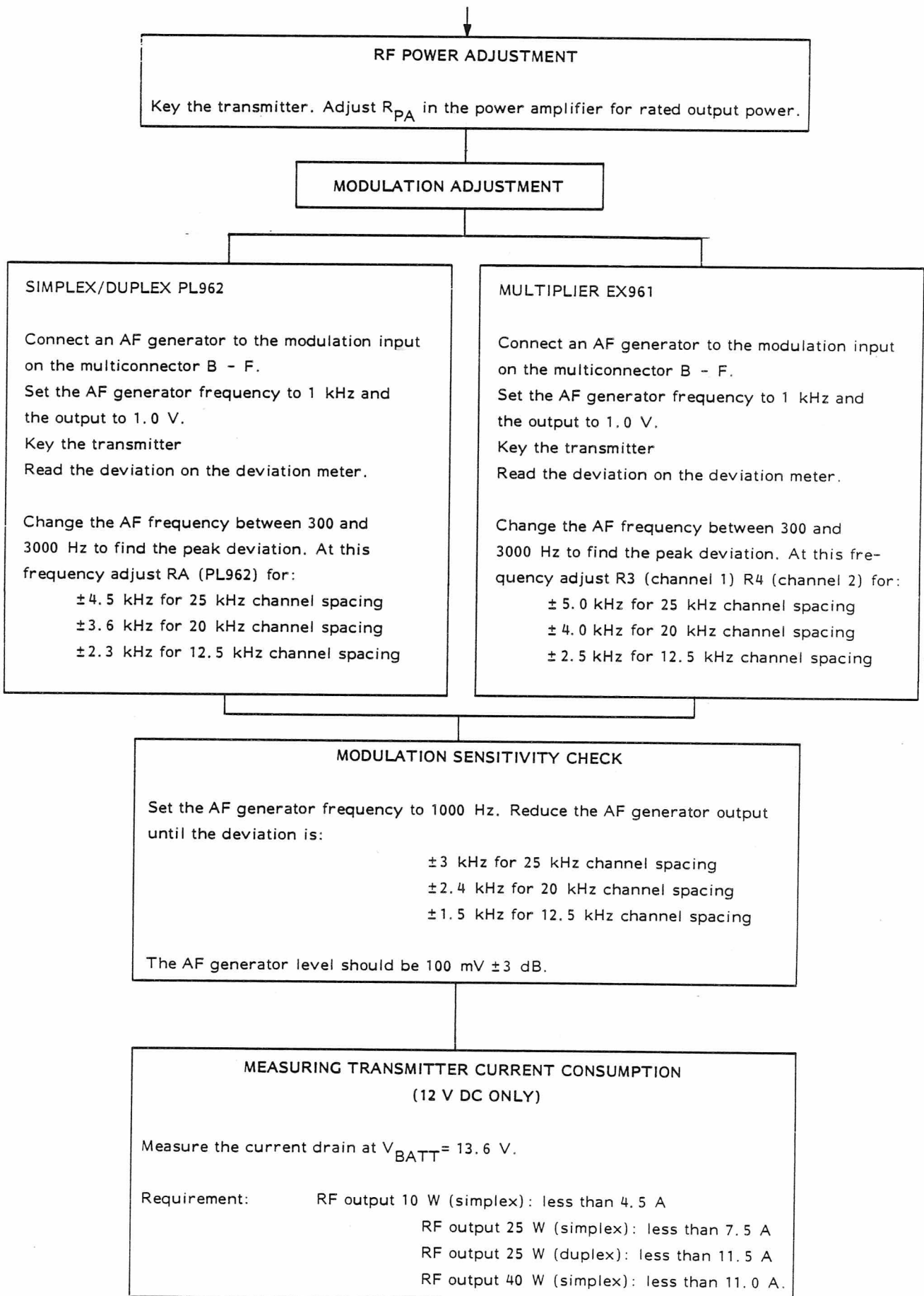

DC9xx

DIRECTIONAL COUPLER

ADJUSTMENT PROCEDURE

Instruments

Spectrum analyzer 1000 MHz
Tracking generator 1000 MHz
Marker generator
3 way 6 dB/50 ohm attenuator pad.
6 dB/50 ohm attenuator pad.

Test setup

Connect the instruments as shown on the test setup diagram.
Set the tracking generator, the marker generator and the spectrum analyzer to the wanted frequency range.
Adjust C1, C2, C3 and C4 for minimum insertion loss.
Reverse the connections to the directionnal coupler.
Adjust C5 and C6 for maximum isolation.
Repeat this attenuation until no further improvement is possible.

DC961 and DC951 only

Adjust C7 for minimum second harmonic contents.

For typical frequency responent curves and data refer to the module description.

DC9xx DIRECTIONAL COUPLER

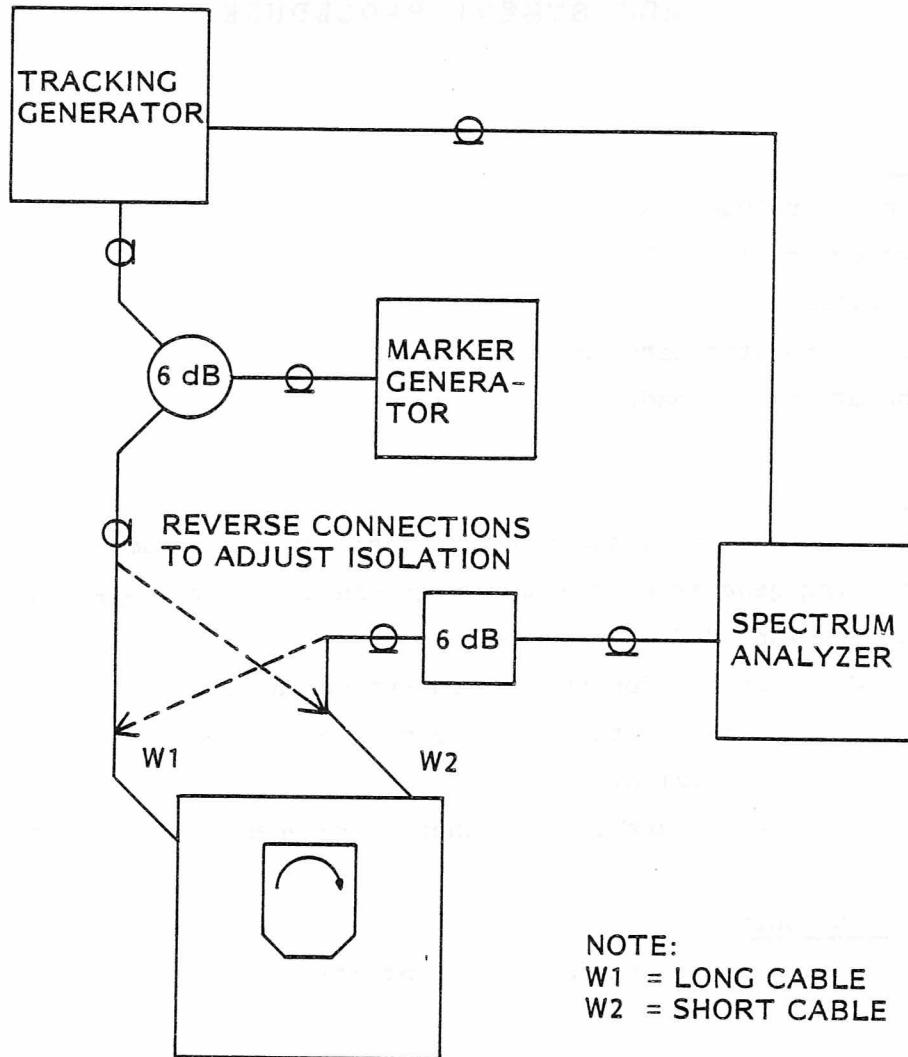

TEST SETUP DC 9XX

D404.604

PS907

ADJUSTMENT AND TEST PROCEDURE

MAINS VOLTAGE

The PS907 is connected to the mains as follows:

- 110 V AC Insert jumper W1
- 220 V AC Remove jumper W1

START CIRCUIT AND OUTPUT VOLTAGE PROTECTION

Turn potentiometers R63, R67, R46, R16 and R11 fully counter clockwise.

Connect a power supply PS1 to C12.

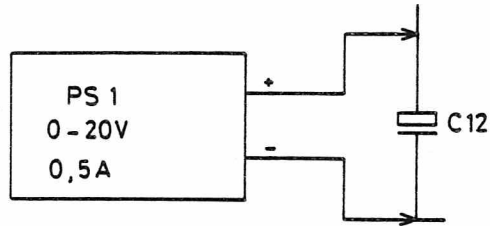

Set PS1 to 0 V and 0.5 A current limiting.

Connect a power supply PS2 to the 13.2 V output.

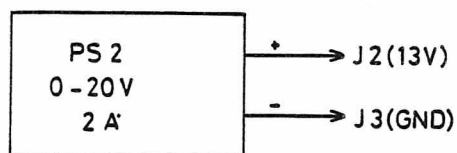

Set PS2 to 0 V and 2 A current limiting.

Connect a voltmeter to the emitter of Q7.

Slowly adjust the PS1 from 0 V to 20 V and check that the start circuit turns on when the voltage reaches 16 V. When the start circuit turns on the voltage on the Q7 emitter is approx. 10 V.

Connect an oscilloscope to the base of Q10.

Decrease the PS1 voltage to 13 V.

Check the voltage waveform.

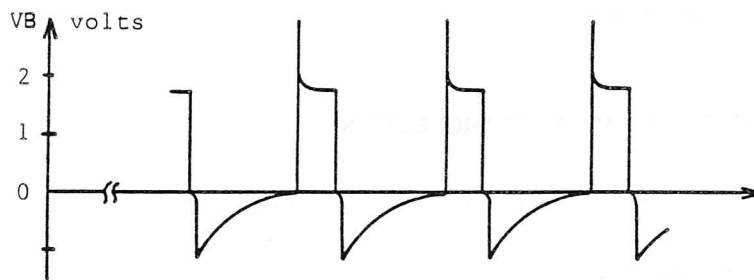

Q10 base waveform

Turn PS2 on and set the voltage to 13.2 V.

Adjust R63 counter clockwise until the waveform at the base of Q10 just disappears.

Set PS2 to 15.5 V.

Adjust R67 clockwise until the output voltage circuit triggers and the voltage drops to 0 V.

Remove PS1 and PS2.

Connect the PS907 to 220 V AC (110 V AC) through a variable autotransformer.

Check the waveforms on Q10 (base, emitter, collector).

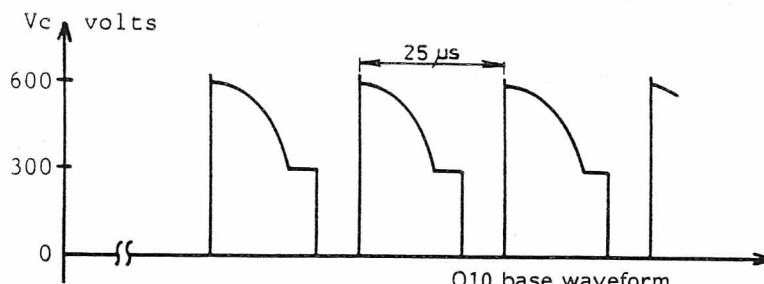

Q10 base waveform

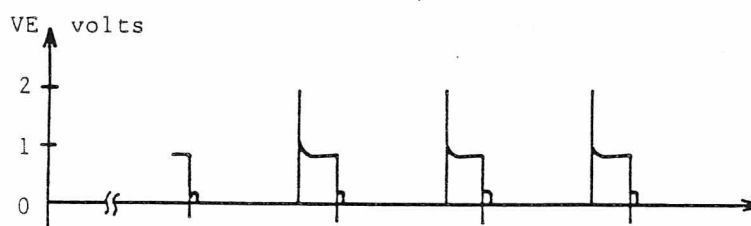

Q10 base waveform

CURRENT LIMITER

Load the 13.2 V output with a variable resistor until the output current is 6.0 A.

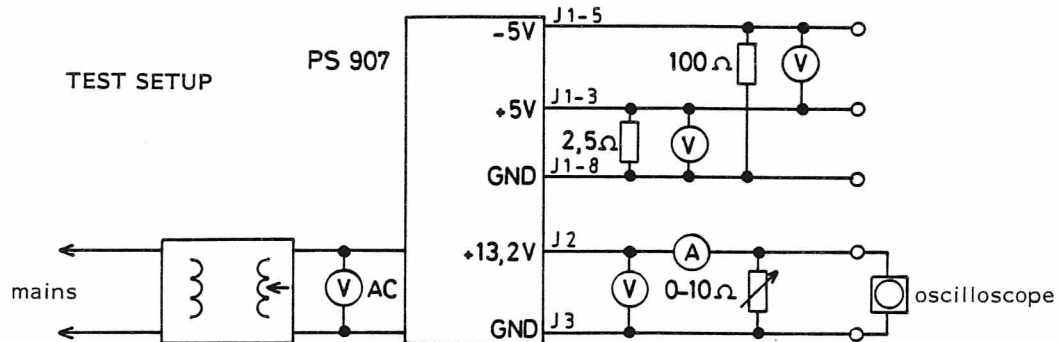

Fine adjust R63 for 13.2 V.

Check that +5 V and -5 V is present.

Load the PS907 until the output current is 11 A.

Adjust R46 clockwise until the output ripple just begins to increase. This increase indicates the point of current limiting.

POWER FAILURE CIRCUIT

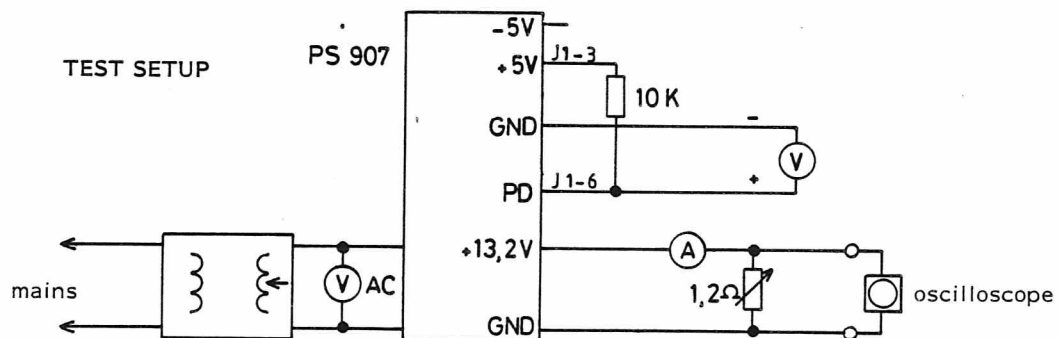

Connect a 10 K resistor from terminal PD to +5 V.

Reduce the main voltage input to 180 V (90 V).

Load the PS907 to 11 A.

Adjust R11 clockwise until the PD voltage just switches from +5 V to 0 V.

5 V REGULATOR

Set the mains voltage to 220 V AC (110 V AC).

Connect a voltmeter to J1-3.

Adjust R16 for 5.2 V.

PS9011/PS9012

ADJUSTMENT PROCEDURE

The power supply module PS9011/9012 is factory adjusted. Thus, adjustment should only take place after repair, if necessary.

13.2 V OVERVOLTAGE PROTECTION (OVP)

Before connecting PS9012 the overvoltage protection circuit must be adjusted.

Connect an external power supply with current limiter to the 13.2 V output J2 (+ 13.2 V), J3 (GND). Set the voltage to 17 V and the current limiting to approx. 100 mA. Now adjust P60 until Q61 just triggers, which will show as a voltage drop in the external power supply. The Over Voltage Protection is now 17 V.

V_{out} 13.2 V OUTPUT

Remove the external power supply.

On PS9011: Connect a 24 V power supply to the input.

On PS9012: Connect a 48 V power supply to the input.

Connect the positive terminal of a multimeter to J2 (+ 13.2 V) and the negative terminal to J3 (GND).

Adjust P1 for $V_{out} = 13.2$ V.

Remove the multimeter

I_{max} (CURRENT LIMITER), I_{FB} (FOLD BACK CURRENT)

Turn P81 (I_{FB}) fully clockwise (max. current).

Connect a load and an amperemeter of 11 A to the output and adjust P2 until the output reaches exactly the point of current limiting.

Now short the output and slowly turn P2 clockwise until $I_{max} = 12$ A (11.5 A - 12.5 A).

Adjust P81 until $I_{FB} = 1.7$ A (1.5 A - 2.0 A).

Remove the short.

V_{out} +5 V OUTPUT

Connect the positive terminal of a multimeter to the connector J1 pin 3,4 and the negative terminal to pin 1.

Adjust P200 until $V_{out} = 5.02$ V ($I_{out} = 2.0$ A).

Remove the multimeter.

UV FOR V_{in} INPUT VOLTAGE (POWER-DOWN SIGNAL)

Connect a light emitting diode in series with a 330 Ohm resistor with anode to pin 3,4 and cathode to pin 6 of J1.

On PS9012 Adjust P70 until the diode turns off. UV voltage for 24 V, UV /24 V) = 21 V.

Remove the light emitting diode and the resistor.

On PS9012 Connect TPS 52 to a 50 V voltage and adjust P70 until the light emitting diode turns off. Now connect TPS 52 to a voltage of 42 V and adjust P71 until the diode turns off:

UV (60 V): 50 V

UV (48 V): 42 V

Remove the light emitting diode and the resistor.

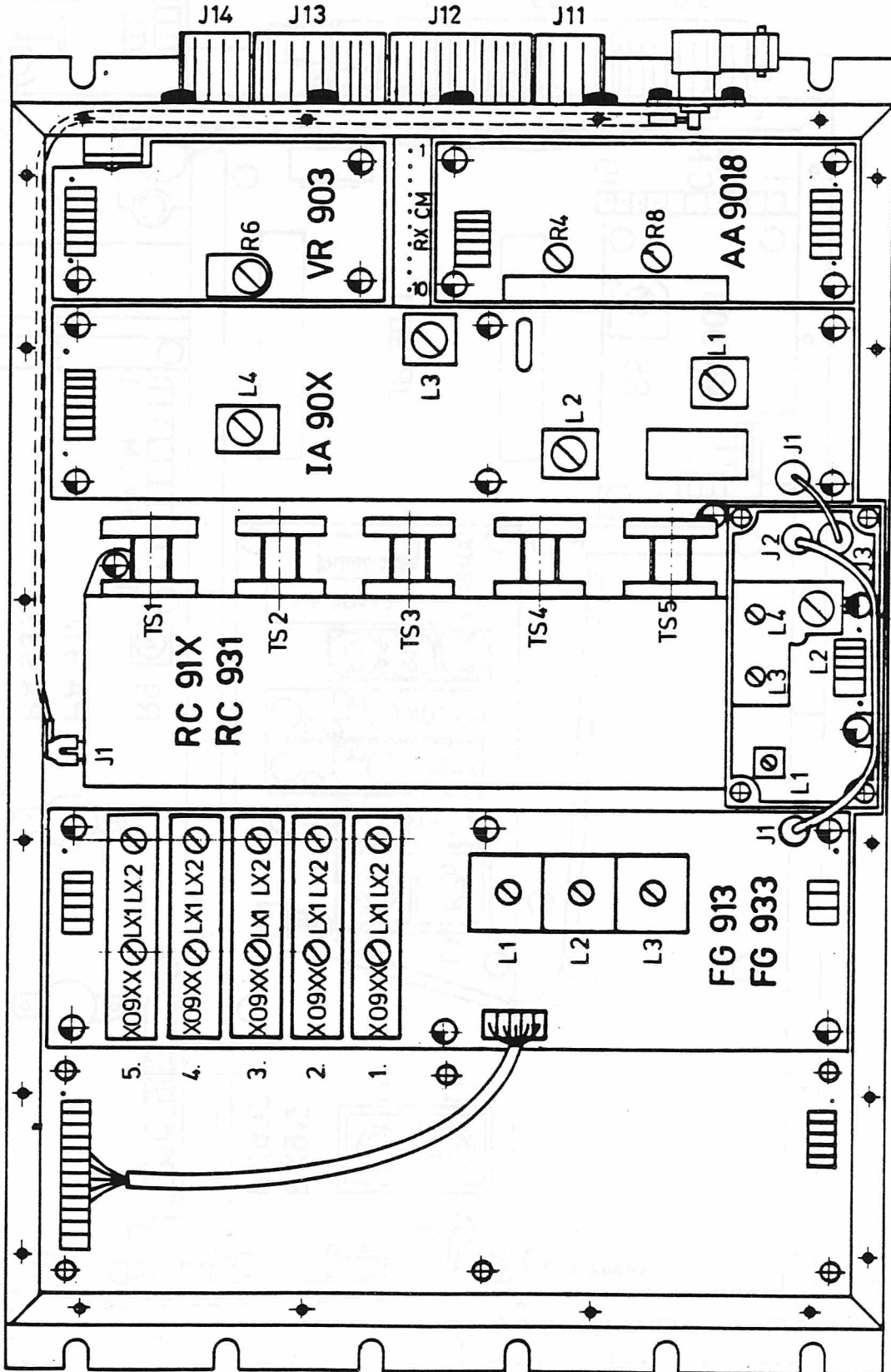

ADJUSTABLE COMPONENTS AND CENTRAL METERING
MULTIPLIER RECEIVER CQF9110 - CQF9330

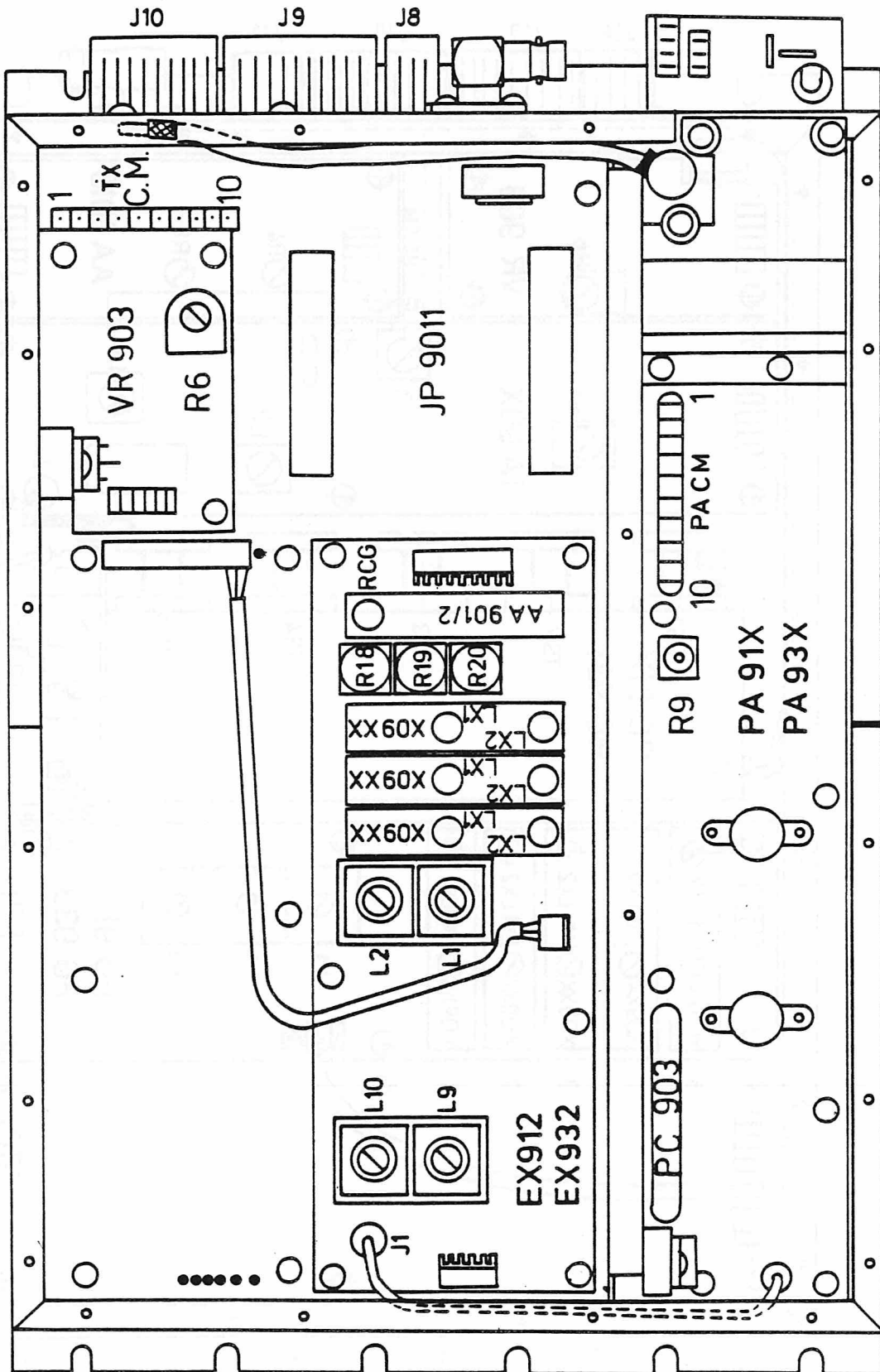

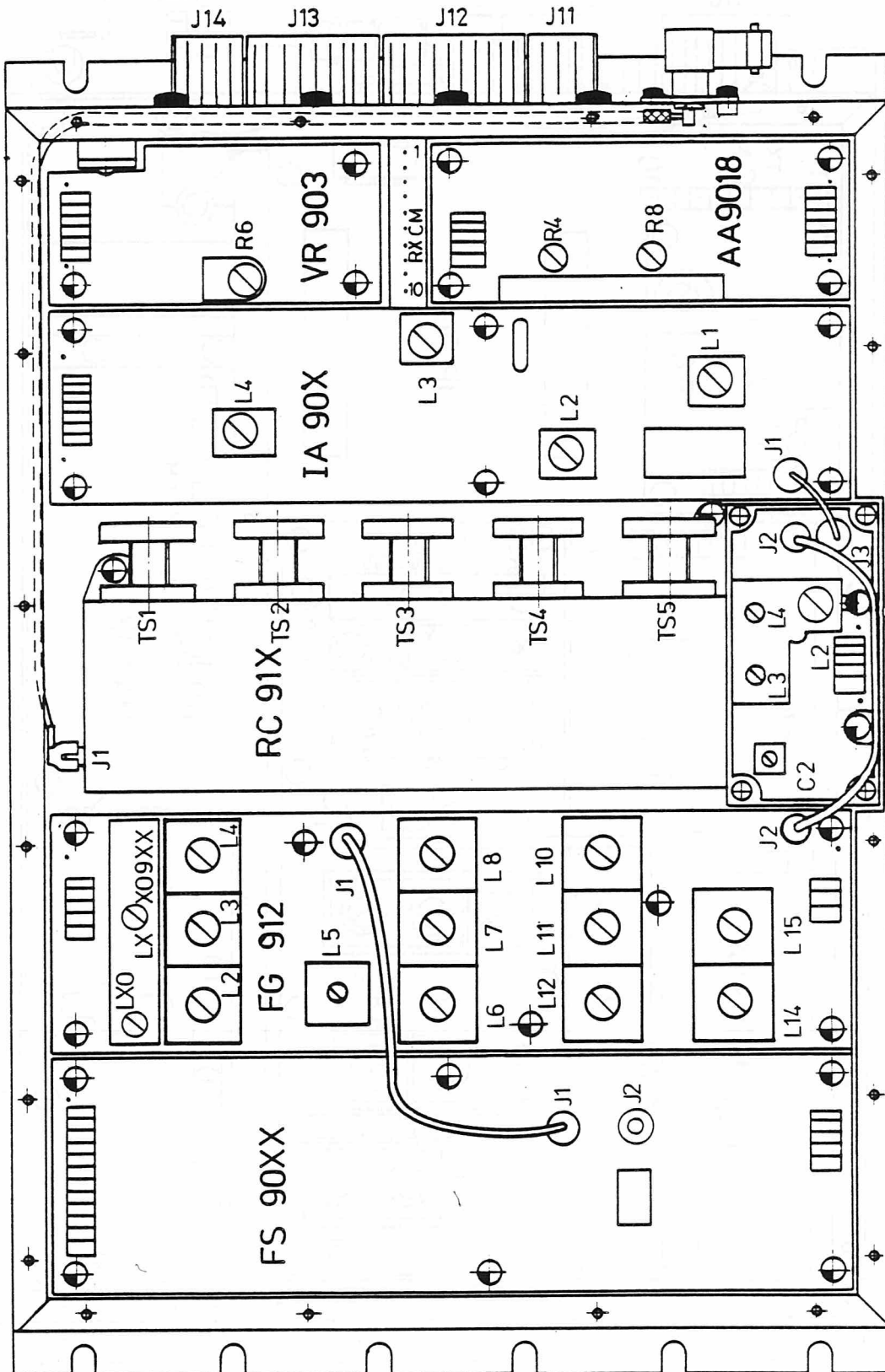

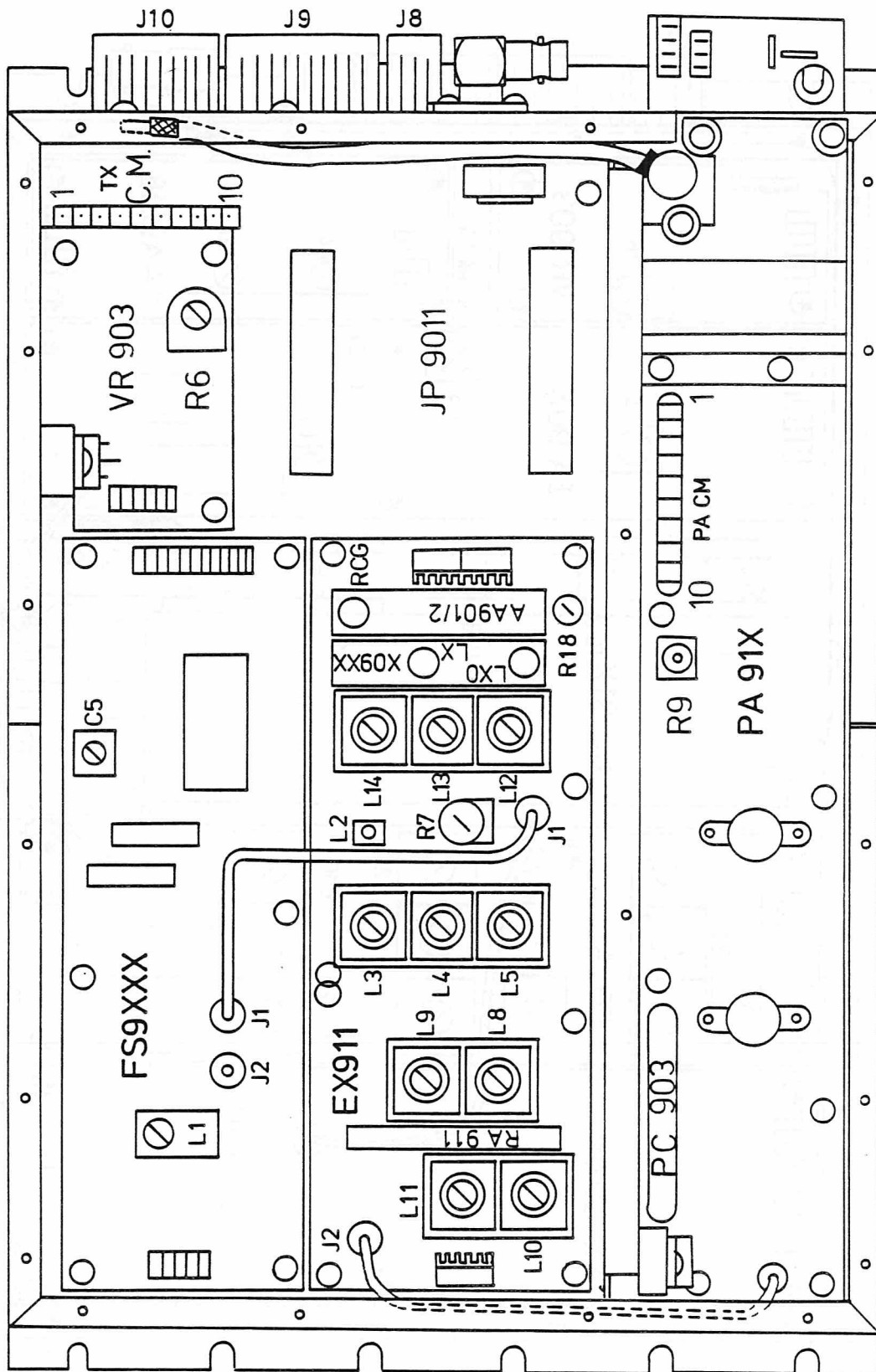

ADJUSTABLE COMPONENTS AND CENTRAL METERING
SYNTHESIZER TRANSMITTER CQF9110

M405. 170

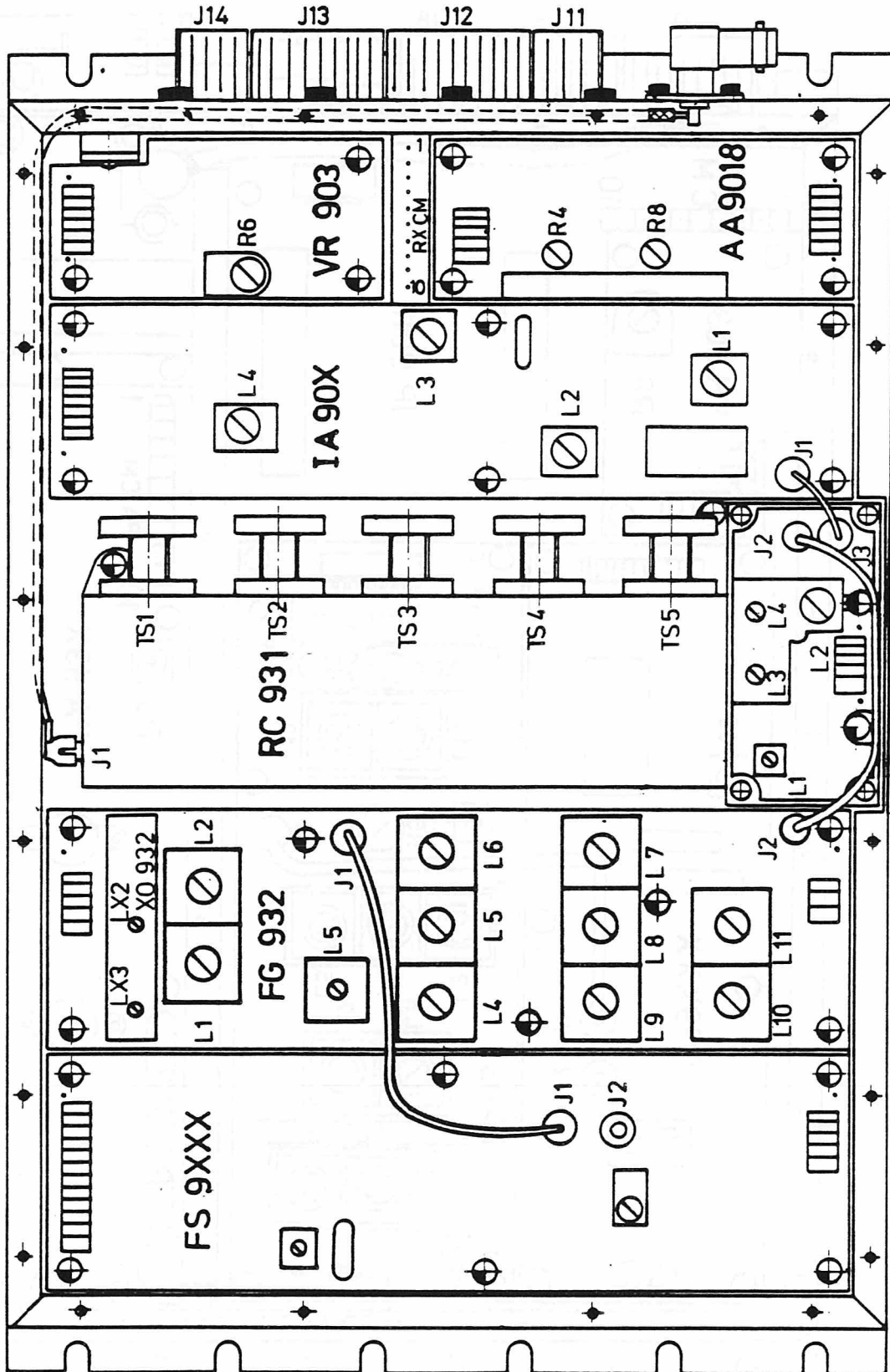

ADJUSTABLE COMPONENTS AND CENTRAL METERING
SYNTHESIZER RECEIVER CQF9330

M405. 176/2

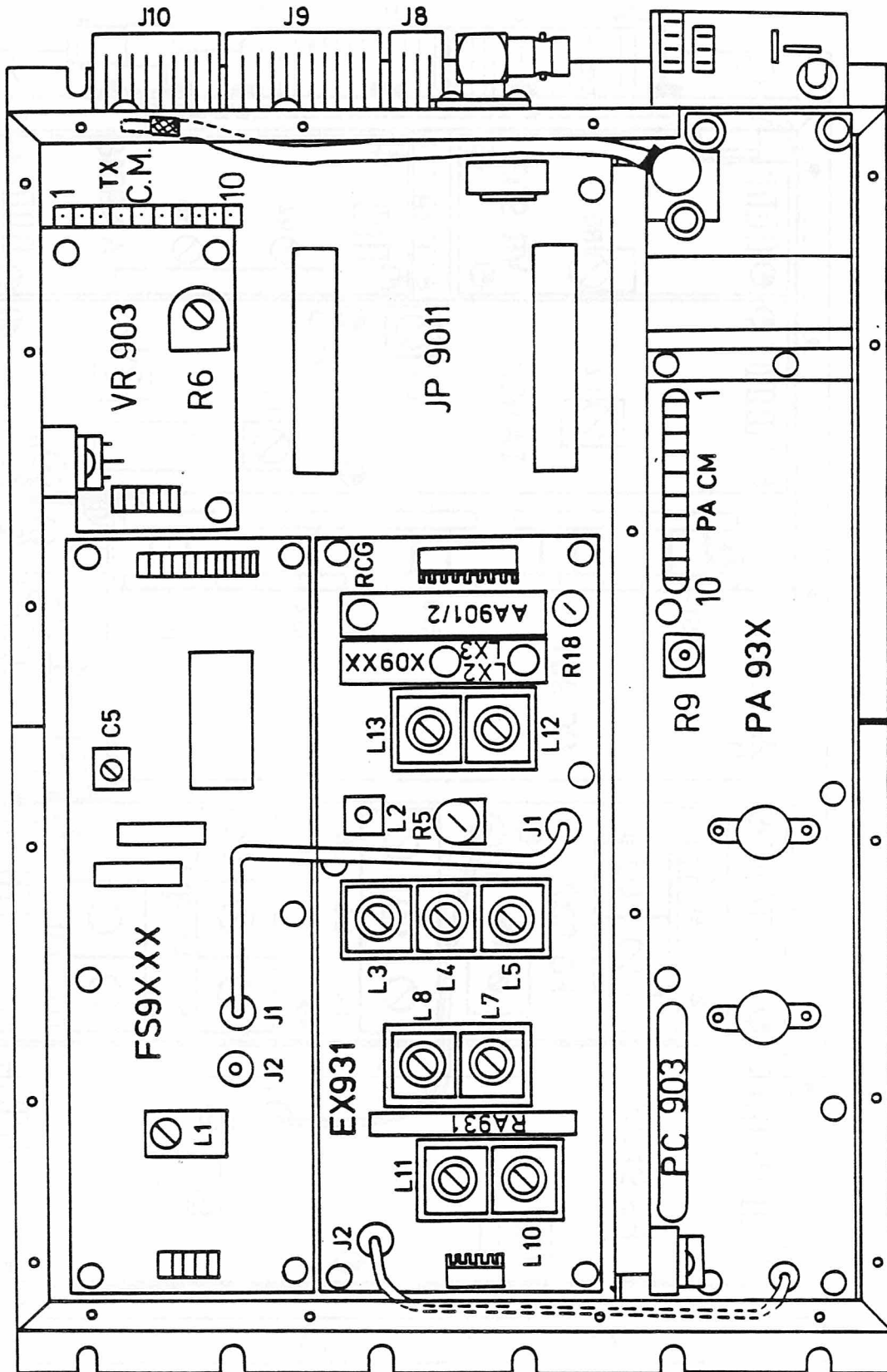

ADJUSTABLE COMPONENTS AND CENTRAL METERING
SYNTHESIZER TRANSMITTER CQF9330

M405. 175/2

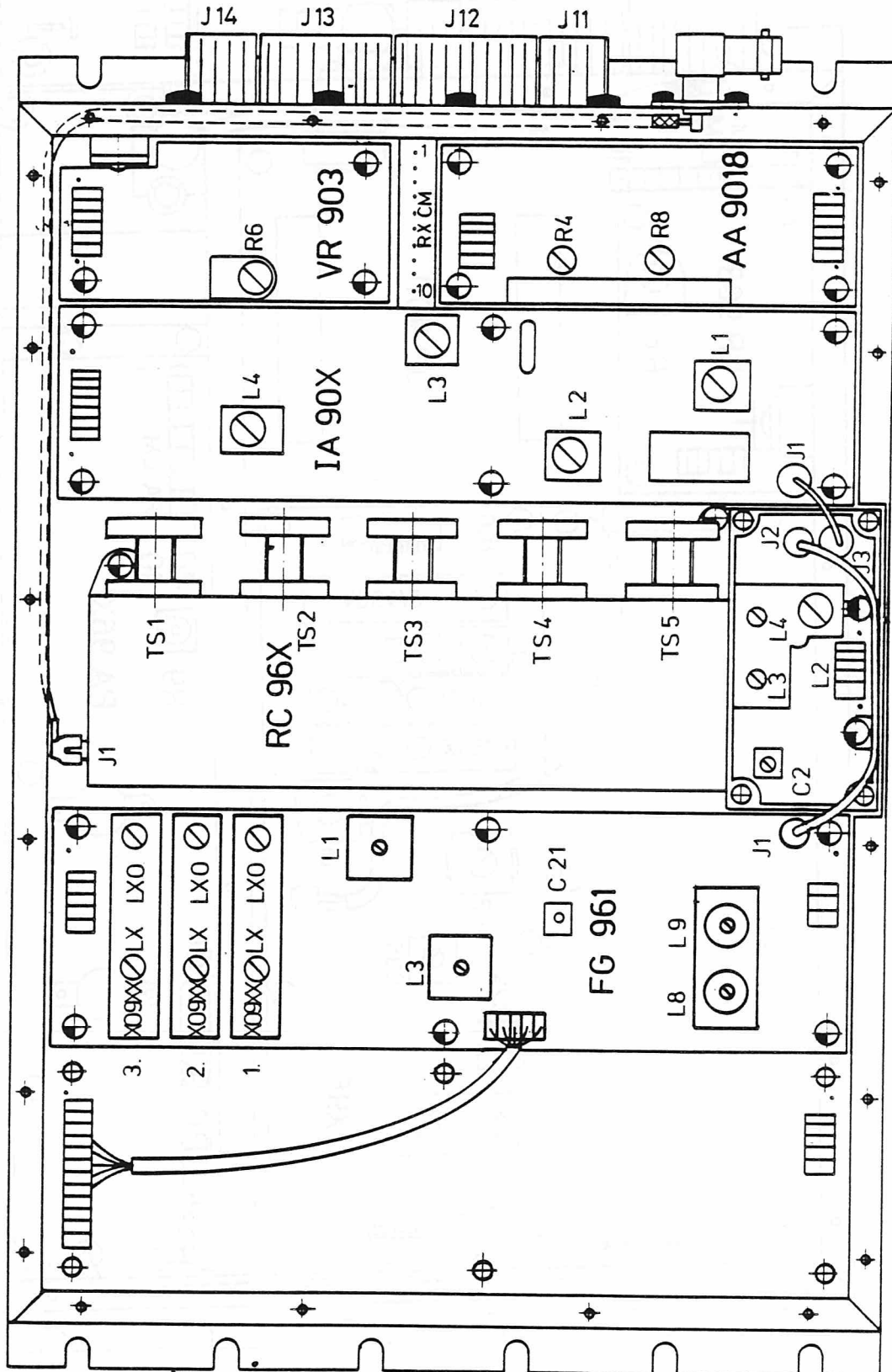

ADJUSTABLE COMPONENTS AND CENTRAL METERING
MULTIPLIER RECEIVER CQF9660

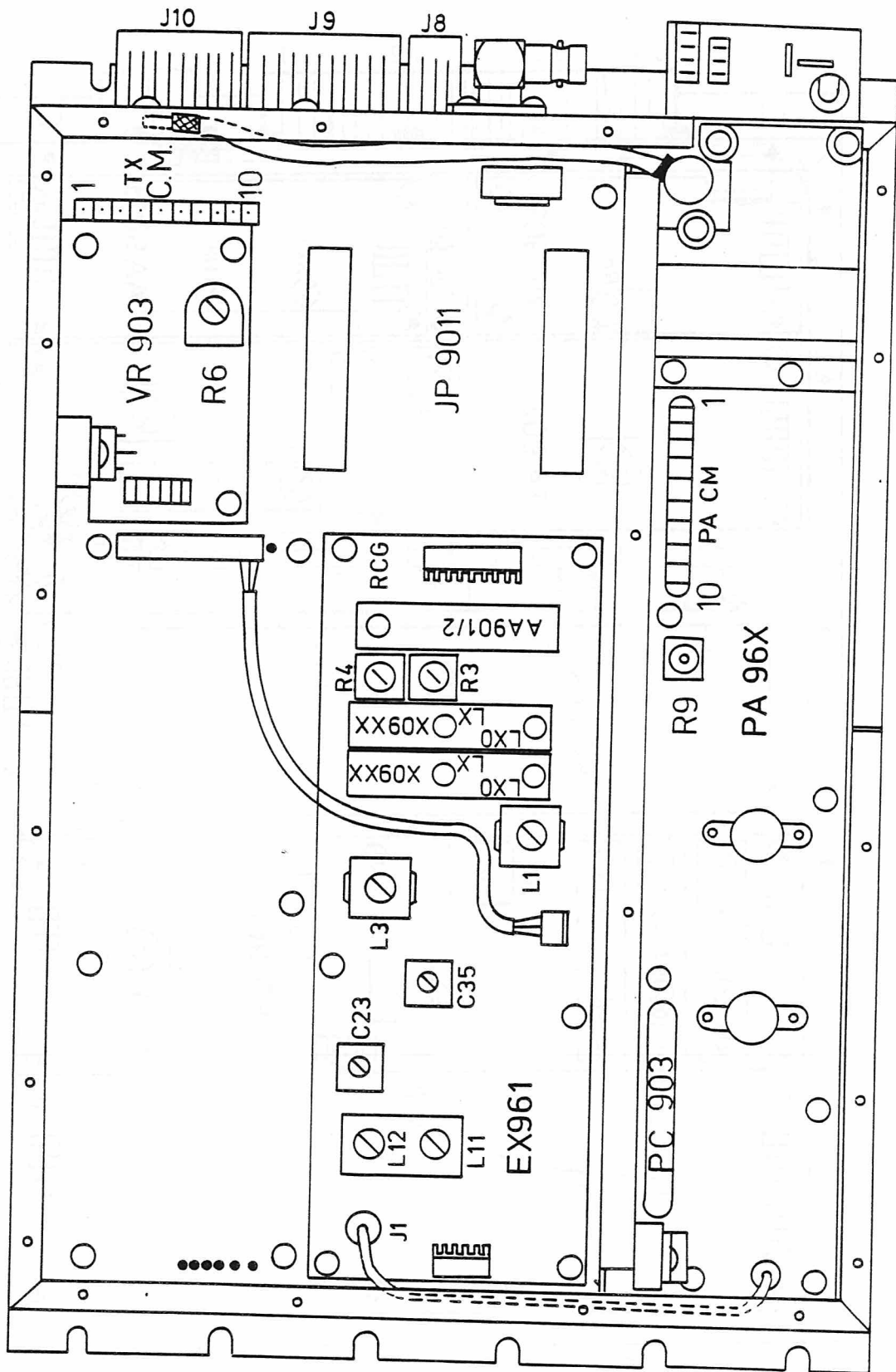

ADJUSTABLE COMPONENTS AND CENTRAL METERING
MULTIPLIER TRANSMITTER CQF9660

M405.179

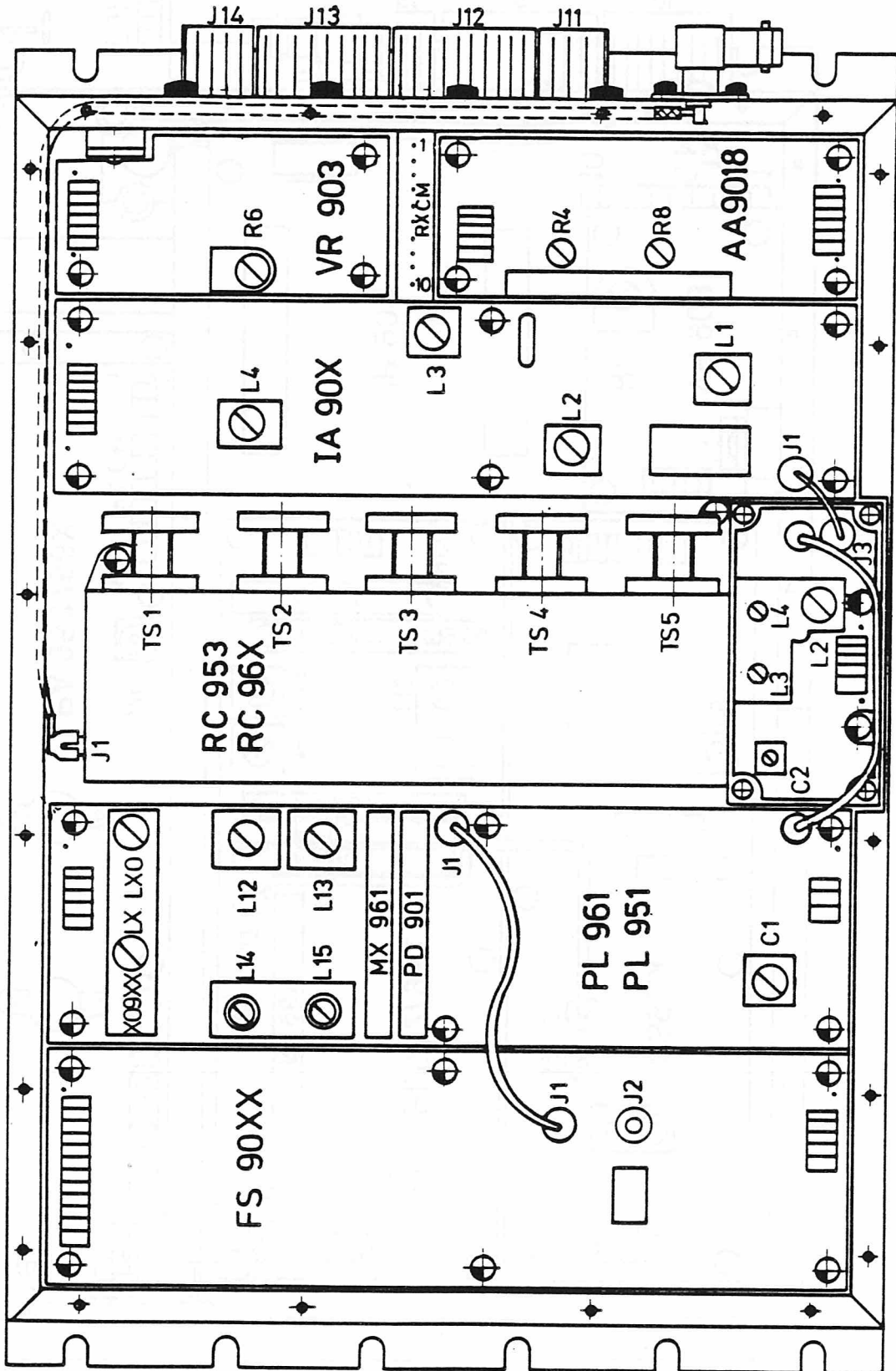

ADJUSTABLE COMPONENTS AND CENTRAL METERING
SYNTHESIZER RECEIVER CQF9660/9550

M405. 178/2

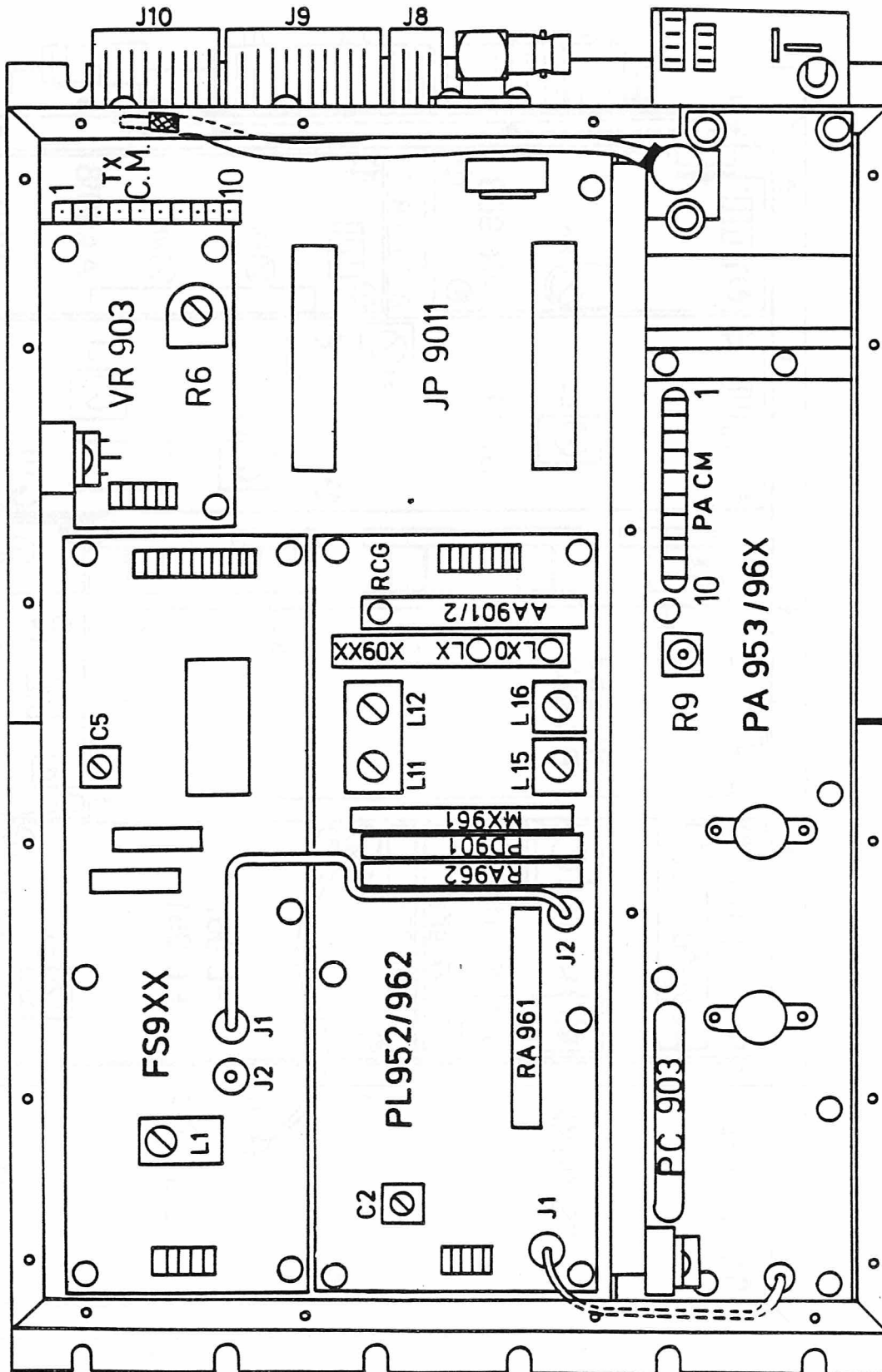

ADJUSTABLE COMPONENTS AND CENTRAL METERING
SYNTHESIZER TRANSMITTER CQF9660/9550

M405. 177/2

Storno

CHAPTER
CHAPITRE
KAPITEL

10

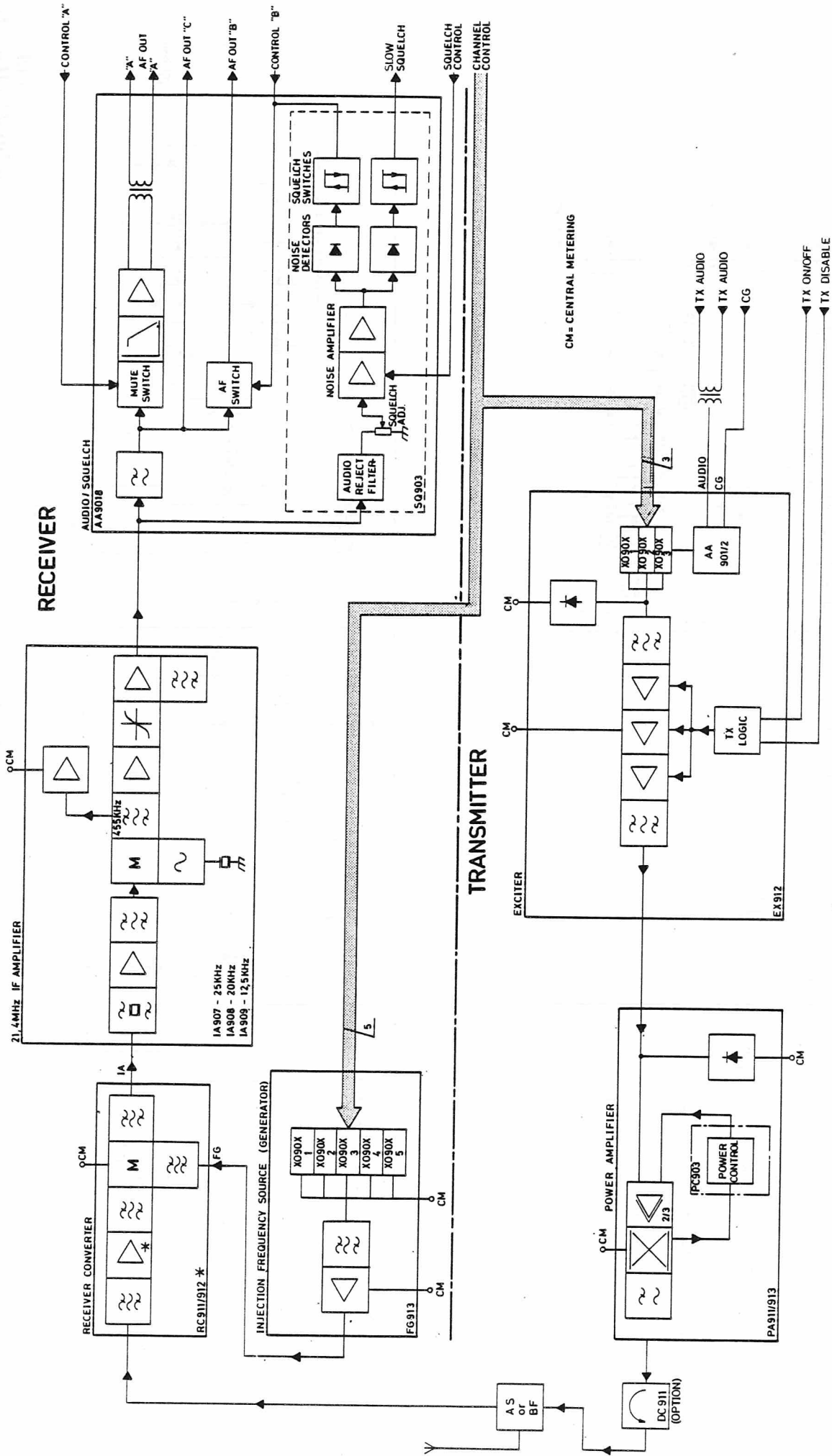

CQF9110
 FUNCTIONAL DIAGRAM
 MULTIPLIER VERSION
 D403.916/2

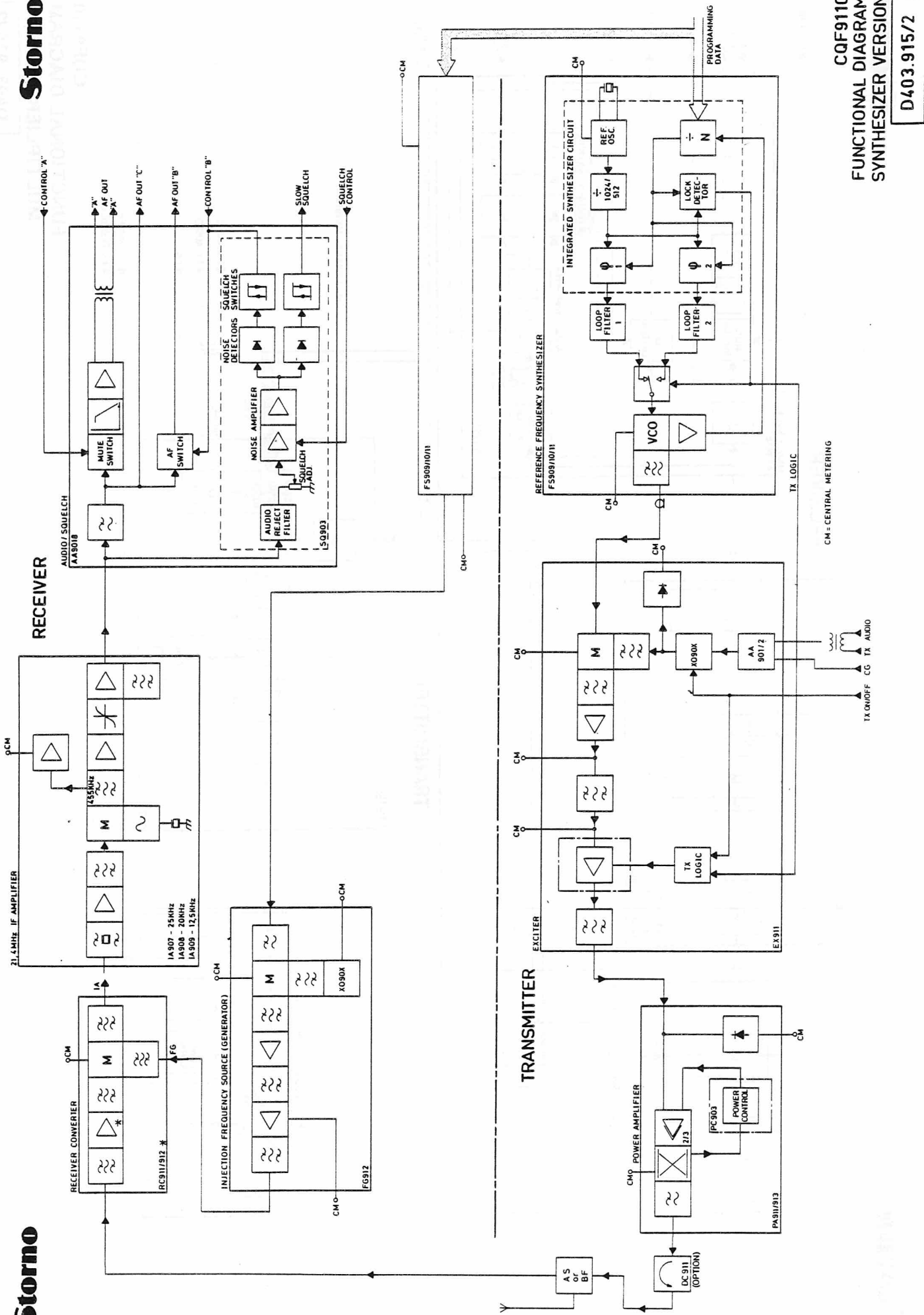

CQF9110
 FUNCTIONAL DIAGRAM
 SYNTHESIZER VERSION
 D403.915/2

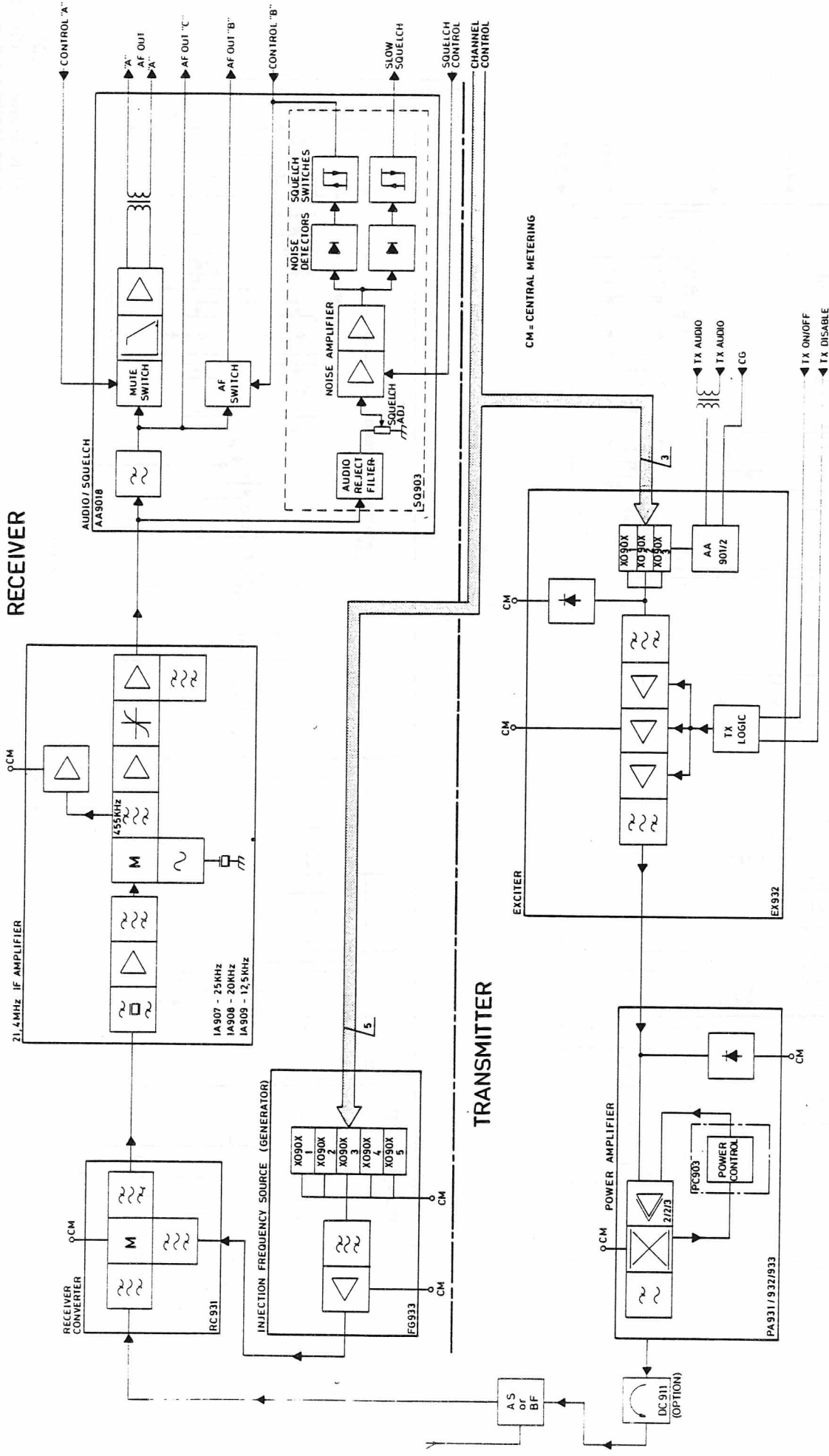

CQF9330
FUNCTIONAL DIAGRAM
MULTIPLIER VERSION
D403.918/2

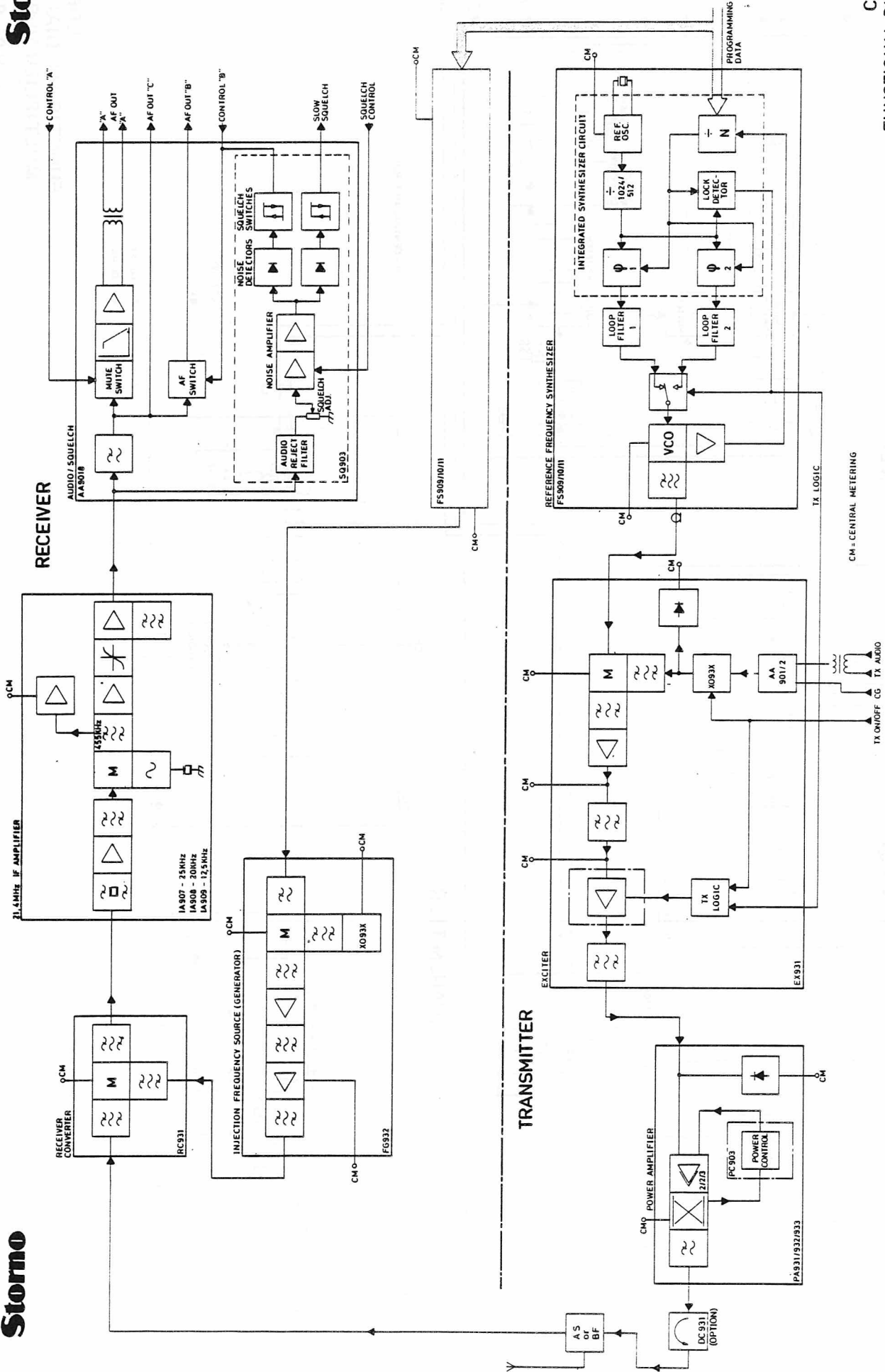

CQF9330
 FUNCTIONAL DIAGRAM
 SYNTHESIZER VERSION

D403.917/2

RECEIVER

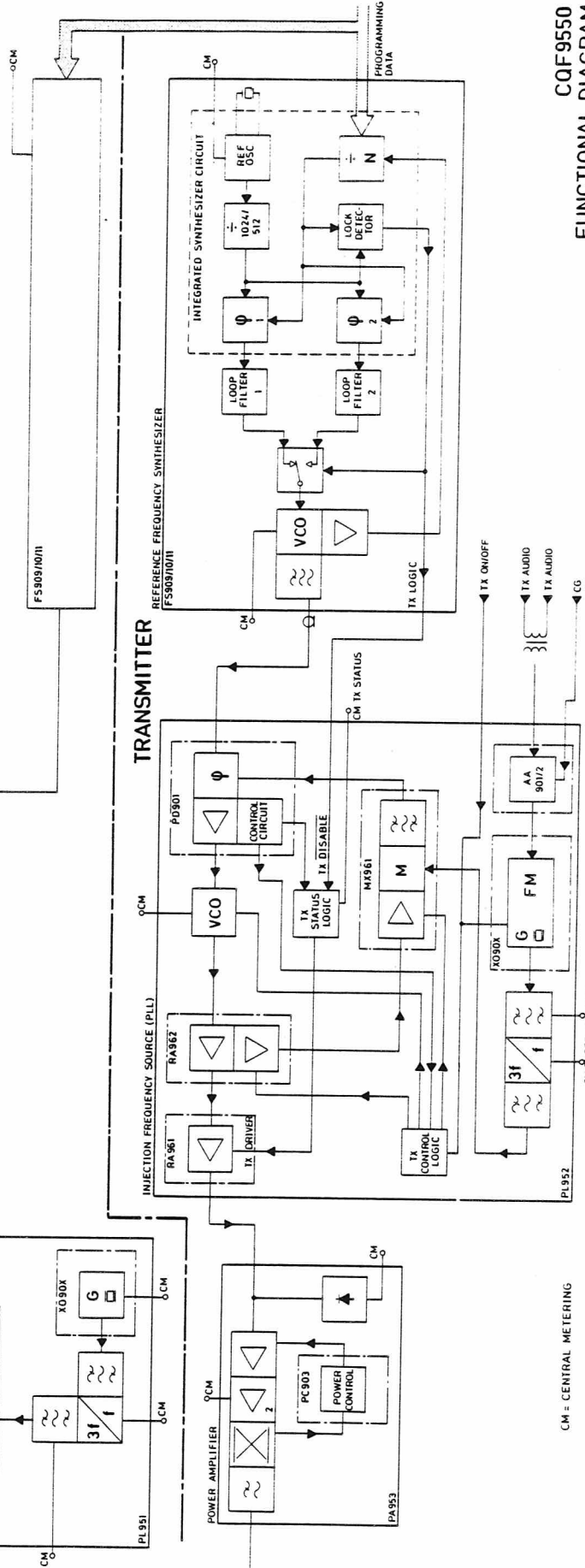
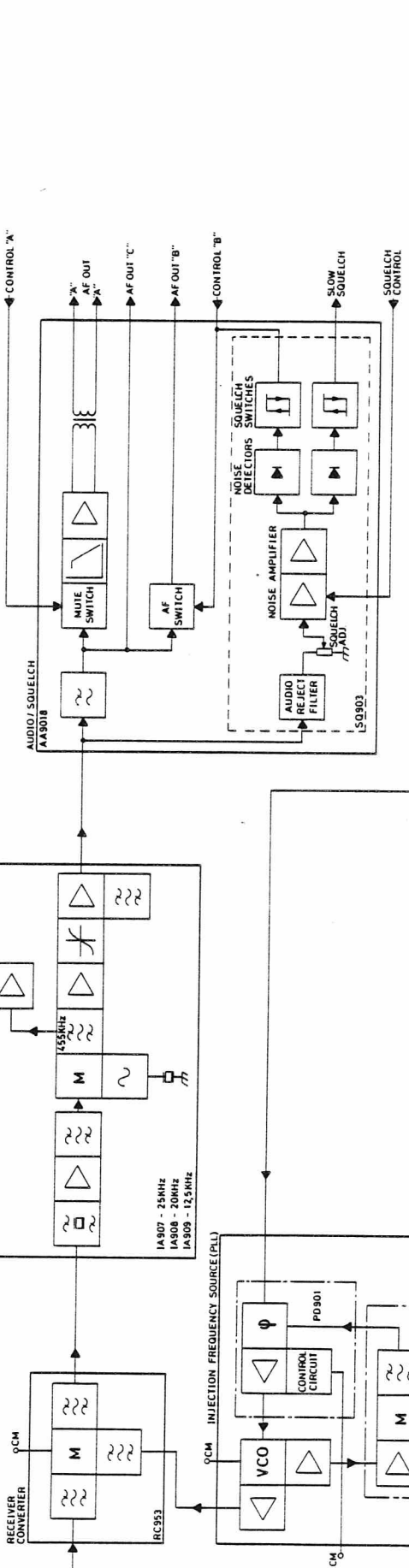

CM = CENTRAL METERING

CQF9550
 FUNCTIONAL DIAGRAM
 SYNTHESIZER VERSION
 D404.135

RECEIVER

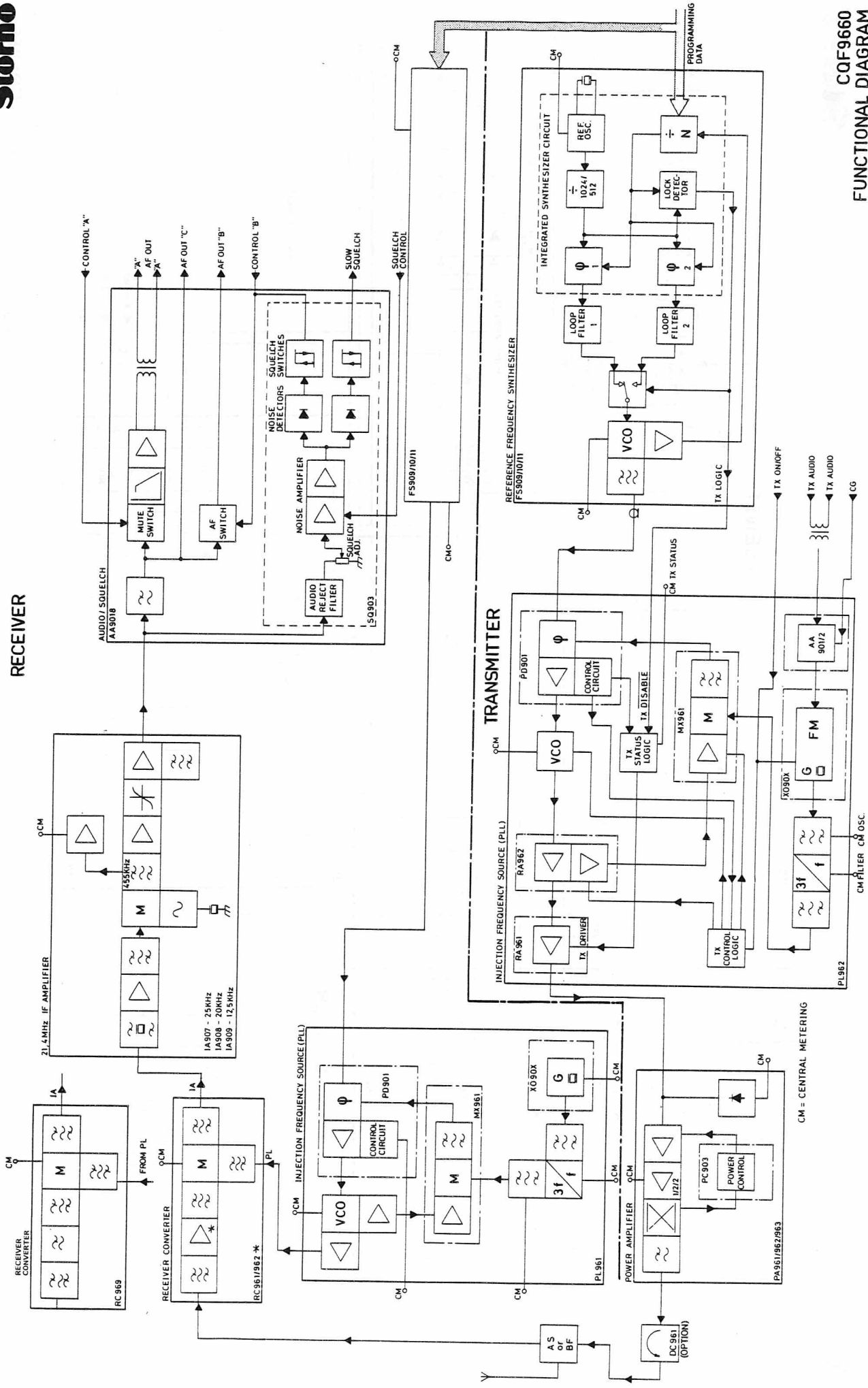

CQF9660
 FUNCTIONAL DIAGRAM
 SYNTHESIZER VERSION
 D403.912/3

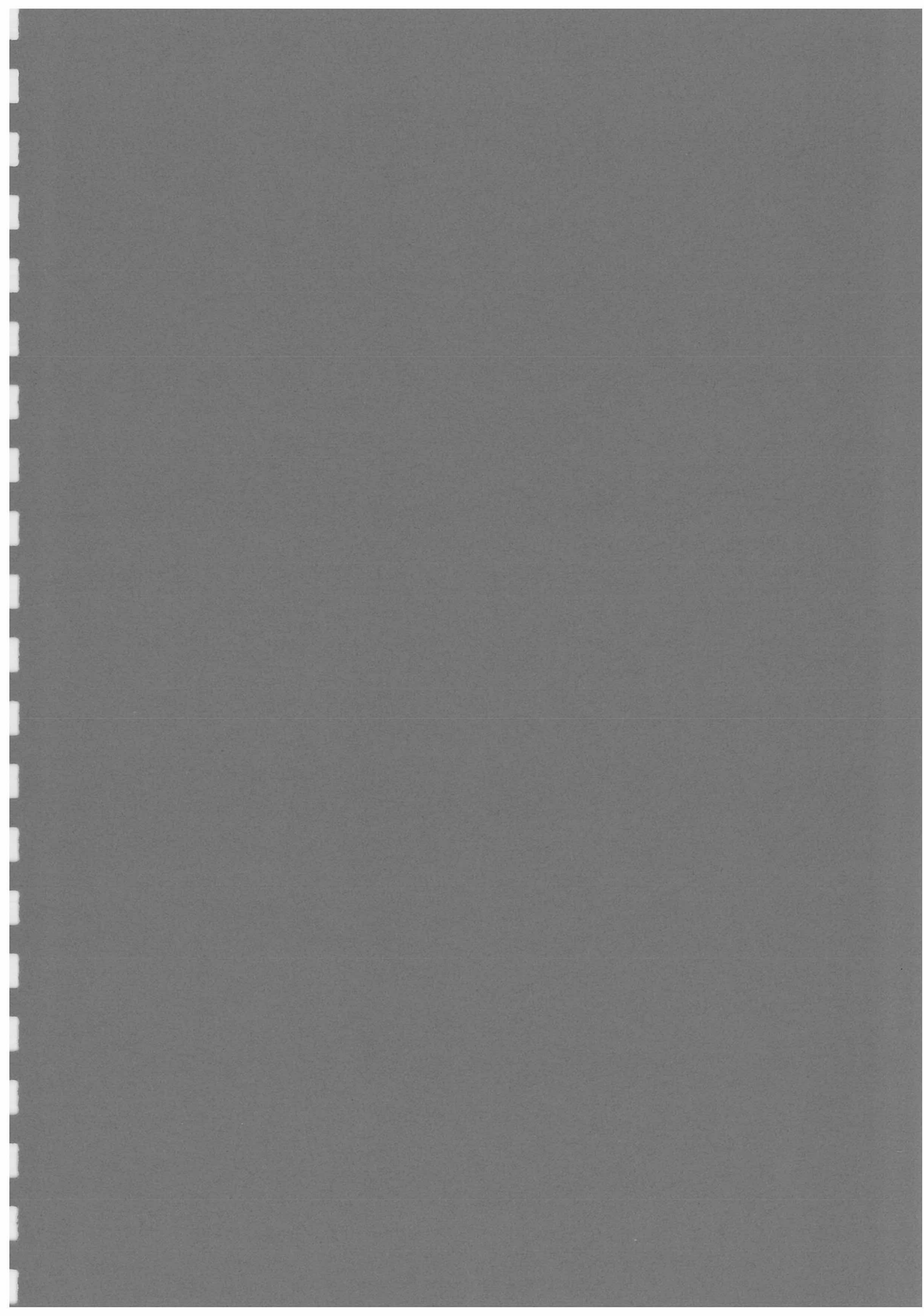

COLOUR CODE/CODE DES COULEURS/FARBKODE

0	BK	BLACK	NOIR	SCHWARZ
1	BN	BROWN	MARRON	BRAUN
2	RD	RED	ROUGE	ROT
3	OR	ORANGE	ORANGE	ORANGE
4	YW	YELLOW	JAUNE	GELB
5	GN	GREEN	VERT	GRÜN
6	BL	BLUE	BLEU	BLAU
7	VT	VIOLET	VIOLET	VIOLET
8	GY	GREY	GRIS	GRAU
9	WH	WHITE	BLANC	WEISS

GRAPHICAL SYMBOLS USED IN CIRCUIT DIAGRAMS

<p>Resistors(R)</p> <ul style="list-style-type: none"> Resistor Resistor with fixed tap Variable resistor Resistor with movable tap (Potentiometer). Varistor (voltage-dependent resistor) Temperature-dependent resistor with negative temperature coefficient Light-emitting diode (photosensitive resistor) Temperature dependent resistor with positive temperature-coefficient. Resistor with preset adjustment 	<p>Diodes(D)</p> <ul style="list-style-type: none"> Diode Bridge rectifier Series-connected stabilizer diodes within one case Light-emitting diode Zener diode (uni-directional) Zener diode (bidirectional) Tunnel diode Backward diode Varactor diode Controlled rectifier, PNP (N-thyristor) Controlled rectifier, NPNP (P-thyristor) Zener diode-programmable. 	<ul style="list-style-type: none"> P-channel IGFET (MOS) N-channel dual gate IGFET (MOS) P-channel dual gate IGFET (MOS)
<p>Capacitors(C)</p> <ul style="list-style-type: none"> Capacitor Variable capacitor Trimmer capacitor Feedthrough capacitor Electrolytic capacitor polarized Polarized capacitor general Electrolytic capacitor non-polarized 	<p>Transistors(Q)</p> <ul style="list-style-type: none"> Transistor, PNP Transistor, NPN Light-sensitive transistor PNP Unipolar transistor with N-type base <p>Junction Field Effect Transistors (JFET)</p> <ul style="list-style-type: none"> N-channel JFET P-channel JFET N-channel dual gate JFET P-channel dual gate JFET 	<p>Integrated Circuits (U)</p> <p>Several integrated circuits contained within one case are designated by one common number followed by an identifying letter (a, b, c, etc.). Thus, circuits U1A, U1B and U1C are contained within one case.</p>
<p>Coils(L)</p> <ul style="list-style-type: none"> RF coil, air core Coupled RF coils, air core RF coil with adjustable core Coil with tap. Helical-coil. 	<p>Insulated Gate Field Effect Transistors (IGFET or MOS)</p> <ul style="list-style-type: none"> N-channel IGFET (MOS) 	<p>Gates</p> <ul style="list-style-type: none"> AND gate. OR gate. NAND gate. NOR gate. Exclusive OR gate. <p>Wired OR (combined OR outputs) (presentation at top is used in detailed diagrams; presentation below is used in functional diagrams)</p>
<p>Transformers(T)</p> <ul style="list-style-type: none"> Transformer with iron core Transformer with adjustable RF cores 	<p>Wired OR (continued)</p>	<p>Wired OR (continued)</p>

GRAPHICAL SYMBOLS USED IN CIRCUIT DIAGRAMS

Flip-flops

Abbreviations used:

S =Set
 R =Reset
 CP=Clock pulse
 PR=Preset
 CL=Clear
 T =Toggle

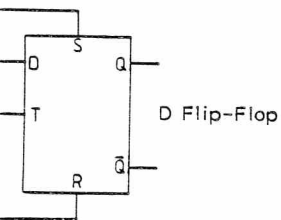
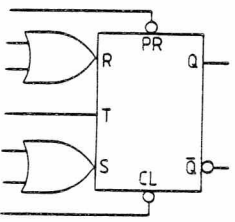
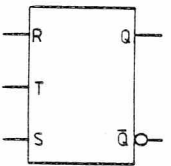
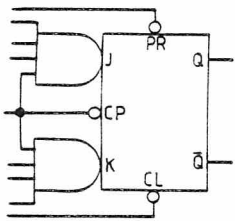
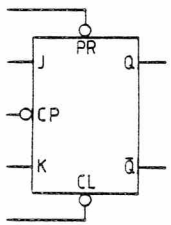
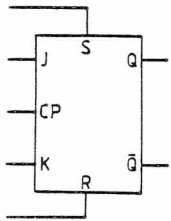

Inverters

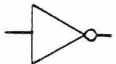

Inverter

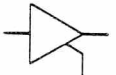

Three-state driver

Operational Amplifiers

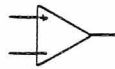

Operational amplifiers.

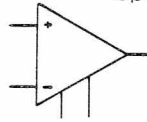

Relays (K)



Single-coil relay



Dual-coil relay



Polarized relay



Slow-acting relay



Slow-release relay



Relay with change-over contacts

Contacts



Open contact (make)



Closed contact (break)



Change-over contact



Change-over contact centre off



Make-before-break

Switches and Keys (S)



On/Off switch



Locking keys or switches:
 push on, push off



Non-Locking self-releasing
 keys or switches

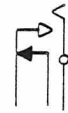

Make-before-break



Locking mutually releasing
 keys or switches (In row
 of push-buttons etc.)



Rotary switch.



ON/OFF switch electrically
 controlled.
 (Not a relay)

Lamps (V)



Indicator Lamp.



Neon Lamp

Fuses and Cut-outs (F)



Fuse



Circuit breaker

Batteries (B)



Battery one cell



Battery multi cell

Feedthrough Filters (Z)



Feedthrough filter

Ferrite Beads (FB)



Ferrite bead

Crystals (Y)



Crystal

Cables and Wires (W)



Usual conductor.



Three conductors



Eight conductors.

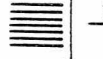

Shift from multiple-line to
 single-line presentation.

























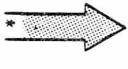





Screened cable.



Coaxial cable.

GRAPHICAL SYMBOLS USED IN CIRCUIT DIAGRAMS

<p>Connectors(J and P)</p> <p> Female (socket) connector.</p> <p> Male (plug) connector</p> <p> Multi-wire connector.</p> <p> Coaxial plug.</p> <p> Coaxial socket.</p>	<p>Replaceable Connections(W)</p> <p> Cross-field connection. (jumper).</p> <p> Strap.</p>	
<p>Loudspeakers(LS)</p> <p> Loudspeaker.</p> <p> Loudspeaker-Microphone.</p>	<p>Miscellaneous</p> <p> Antenna</p> <p> Buzzer.</p> <p> Horn.</p> <p> Directional Coupler.</p> <p> Circulator.</p> <p> Multiconductor bus (used in logic diagrams) * = Identifying bus label e.g. DATA, ADDRESS....</p> <p> Chassis or frame connection</p> <p> Grouping of leads.</p> <p> Crossing of wires.</p> <p> Junction of connected wires</p>	
<p>Telephones(TEL)</p> <p> Telephone.</p> <p> Single headphone. (Earphone).</p> <p> Double headphone.</p>		
<p>Microphones (M)</p> <p> Microphone.</p>		
<p>Meters etc.</p> <p> Indicating instrument.</p> <p> Balancing instrument. (Galvanometer).</p> <p> Basic letters see DESIGN STANDARD 10.02.3.1 section 12.</p>		
<p>Test Points</p> <p> DC test point.</p> <p> AC test point.</p>		